

Kosnic

2016

LED LUMI COMP CFL HALO

ISSUE 2

a touch of brilliance



LED Filament
Globe Lamp

Head Office

Kosnic Lighting Ltd.
Unit D2 Kennetside
Bone Lane
Newbury
Berkshire, UK
RG14 5PX

Sales/general enquiries:
Tel: 0845 838 6851 (option 1) sales@kosnic.com Fax: 0845 838 6852
Project & Bespoke services:
Tel: 0845 838 6851 (option 2) project@kosnic.com
Export Enquiries:
Tel: 0845 838 6851 (option 4) export@kosnic.com



Kosnic Lighting France SAS

88 avenue de L'Europe
77184 Emerainville

Tel: +33 (0)9 52 37 66 64
Fax: +33 (0)9 57 37 66 64
Orders / Commandes: admin-klf@kosnic.com
Information / Renseignements: contact-klf@kosnic.com

Since our inception in 2004, Kosnic Lighting has rapidly become a leading designer, manufacturer and established expert in LED technology – LED lamps, luminaires and bespoke lighting solutions.

With a product portfolio of over 1000 items, our LED lamps, luminaires and modules are widely recognised as amongst the most cutting-edge, reliable and wide-ranging products on the market. Serving residential, commercial and public sector lighting requirements, Kosnic delivers quality, cost-effective and environmentally responsible LED lighting solutions.

An independent British company, Kosnic's headquarters are in Newbury Berkshire, with

manufacturing bases located in the UK and China. In addition, the company has a dedicated research laboratory, the Kosnic Technology Centre based in Shanghai, dedicated to maximising the energy, aesthetics and cost-saving potential of LED technology for our customers.

Accreditations

In 2015, Kosnic was awarded ISO 9001:2008 accreditation for quality management systems and underwent a stringent evaluation process to join the elite group of Accredited Suppliers to The Carbon Trust, an independent organisation that is championing a sustainable future through the use of renewable, energy-efficient and low carbon technologies.



Customer Service

Our dedicated Customer Service Team is available Mon-Fri to help with any queries you may have, from our Order Processing Team who ensure your orders are processed on time, our dedicated team of Account Managers always available to help your business succeed right through to our Returns Team ready to resolve any issues.

Internal Sales Team

At Kosnic our customers are important to us, so we have an Internal Sales Team to ensure they have all the information they require to help promote the Kosnic Lighting range. With our monthly special offers and other promotions, we help our customers sell quality products at the best prices. There is no hard telephone sales calls - just a friendly call to make sure Kosnic customers are happy customers.

Warehouse

Our warehouse has trebled in capacity over recent years to 35,000 square feet. This allows us to ensure that most deliveries can be despatched on the same day that the order is placed.

We also reuse and recycle packaging wherever possible, to ensure nothing is wasted.

Showroom & meeting rooms

Our showroom facility demonstrates the latest in Kosnic LED lighting technology but is also available for our distributors and wholesalers looking to host sales events, technical training or simply to see what is possible through LED lighting.

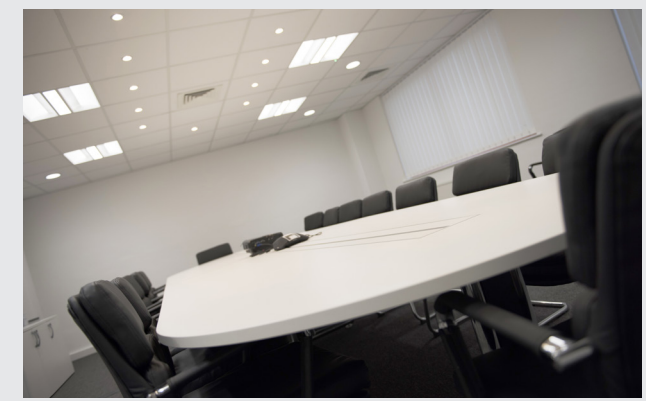

Conference room

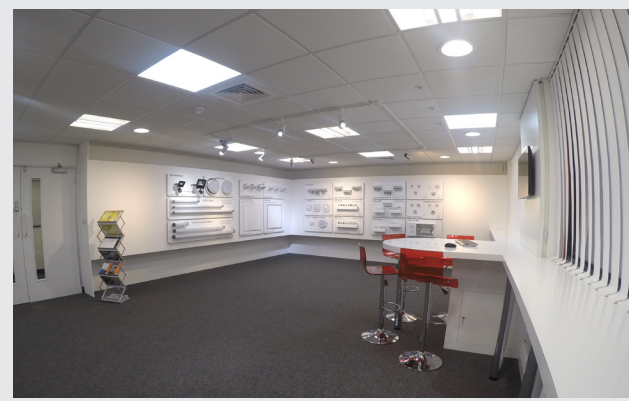

Showroom

from design, specification, manufacture, import and distribution. By specifying all of our own components, it gives us fantastic quality and flexibility ahead of the competition.

At Kosnic, we aim to anticipate the future needs of our customers. As well as remaining at the forefront of LED innovation, that means offering the very highest standards of service to all customers.

We're known for our friendliness and the fact that we aim to give our customers a personal, engaging service.

Export

In 2010, our Export department was created. As a result, we now have over 50 distributors in more than 20 Countries in 4 Continents – all of whom are looked after by a dedicated team.

Due to growing success, Kosnic France was then created in 2015 to better serve customers in France and other French speaking countries.

We are always interested in finding new business partners and expanding our network of overseas distributors. If you are interested in representing our product, we would like to hear from you.

Dedicated to Design, Manufacture and Distribution

LED technology is revolutionarily changing the lighting industry. With our own dedicated research laboratory, the Kosnic Technology Centre in Shanghai, we are able to drive the transformation in LED technology and develop new production methods.

KTC engineers with extensive experience in lighting design, electronics, heat management and manufacturing process collaborate on the development of LED lamps and supporting products.

We are completely unique as a UK based lighting company in complete control of the supply chain

Project & Specification

At Kosnic, the design, development and manufacture of low energy LED solutions is our business. So is helping our customers think about their lighting and how it can help combat ever-increasing energy prices, reduce energy consumption and lower carbon emissions.

Lighting will typically account for around 25% to 40% of a buildings energy usage. Kosnic LED lighting can dramatically reduce this, using between 50% and 90% less energy than traditional lamp types such as halogen, fluorescent or filament.

What We Do

Services available to you include:

- Client liaison and site surveys
- Cost of ownership calculations
- Lighting design schemes
- Technical support
- Sales tools and product selection advice

Working closely with our Wholesale and Distribution partners, our aim is to help you build a compelling business case to persuade customers of the benefits of switching to a Kosnic LED solution.



Client Liaison and Site Surveys

To enable us to build a picture of the project, provide accurate replacement models and cost saving calculations, we require information such as the type of lamps currently being used, quantities involved, working areas and usage. Depending on the complexity and scale of the project, we will visit the premises to conduct a site survey.

Cost Of Ownership Calculations

After conducting a site survey, we will prepare a detailed cost analysis to present to both you and the client. Our cost of ownership calculator highlights the key comparisons between existing lamps and the proposed Kosnic LED replacement, showing the overall annual spend reduction, kWh reduction, CO2 emission reduction and payback period. Whatever the size of the project, helping secure the clients approval is our aim.

Lighting Schemes

At Kosnic, our technical expertise and experience within the lighting industry allows us to develop lighting schemes that are positive for people as they are sustainable for the environment and for business. The Project Team can create a lighting scheme for your clients using industry recognised RELUX software. Once the design criteria such as room dimensions, ceiling height and working area have been established, we can present a professional 3D design visual back to the client. This can even include elements such as work surfaces, tables, windows and chairs. Of course, if you already have an in-house lighting design team, we are happy to work alongside you and provide the necessary specification and photometric data required.

Relux

In 2015, Kosnic Lighting entered into a new partnership with Relux Informatik AG Switzerland, the international lighting planning software expert. Kosnic's lighting solutions are now featured on the Relux platform to assist the industry in its lighting planning.

Bespoke Design

Bespoke Services: Kosnic has many LED products particularly well suited to specification and project work. But from time to time the best solution needs to be tailor-made.

With our technical expertise and ability to turn a conceptual idea into a finished product within very short lead times, whilst maintaining 100% product quality at every stage, makes Kosnic the first and obvious choice for Bespoke Solutions.

We are able to provide a complete specification, design and manufacturing service for those who wish to create an ideal and unique luminaire for a specific purpose or environment.



Kosnic's Project Team can create a lighting scheme for your clients using Industry recognised RELUX software.

Image 1: False colour rendering
Image 2: Visual 3D render

Display

Kosnic have an extended range of LED display options, perfect for creating ambience, accenting or general lighting in any area. Ideal for hospitality, retail, commercial or public buildings, our LED lamps offer maximum energy saving and maintain environmental standard.



- High efficiency of up to 70lm/W, save up to 85% energy
- Premium SHARP Chip on Board (COB)
- High CRI over 80Ra
- Long life of 30,000h



Order Code	Power	Type	Cap	Beam Angle	Colour	Lumen*
KTC15AR111	15W	ES111	GU10	30°	3000K 6000K	1000lm(970lm) 1050lm(1020lm)
KTC15AR111	15W	AR111	G53	30°	3000K 6000K	1000lm(970lm) 1050lm(1020lm)
KTC15P38	15W	PAR38	E27	30°	3000K 5000K	1000lm(970lm) 1050lm(1020lm)
KTC10P30	10W	PAR30	E27	30°	3000K 5000K	650lm(620lm) 700lm(670lm)
KDIM05P16 (Dimmable)	5W	PAR16	E14	45°	3000K 6500K	310lm(230lm) 350lm(260lm)
KTC05P16 (Non-Dimmable)	5W	PAR16	E14	45°	3000K 6500K	310lm(230lm) 350lm(260lm)
KTC04MR11	4W	MR11	GU4	38°	3000K 4000K 6500K	230lm(220lm) 230lm(220lm) 240lm(230lm)
KTC02MR11	2W	MR11	GU4	38°	3000K 4000K 6500K	110lm(100lm) 115lm(105lm) 115lm(105lm)

* Total lumen (lumen measured in 90°/120° Cone)

Filament

The KTC LED Filament lamp has a traditional appearance and gives an even spread of light in all directions. Our filament range is highly efficient, with 100lm/W or more, giving a quality of light that creates an inviting living space compared to traditional filament, the KTC LED filament range offers huge energy savings without compromising on brightness. The lamps can quickly replace filament products in domestic and hospitality lighting applications, and once in place rapid payback is achieved.



- High efficiency of up to 100lm/W, save up to 90% energy
- Sapphire based LED filament
- High CRI over 80Ra
- Long life of 20,000h



Order Code	Power	Type	Cap	Finish	Colour	Lumen
KFLM02CND-CLR	2W	Candle	B15 E14 B22 E27	Clear	2700K	240lm
KFLM04CND-CLR	4W	Candle	B15 E14 B22 E27	Clear	2700K	440lm
KFLM02BTP-CLR	2W	Bent-tip Candle	E14 B22 E27	Clear	2700K	180lm
KFLM04BTP-CLR	4W	Bent-tip Candle	E14 B22 E27	Clear	2700K	350lm
KFLM02TWT-CLR	2W	Twisted Candle	E14 B22 E27	Clear	2700K	160lm
KFLM04TWT-CLR	4W	Twisted Candle	E14 B22 E27	Clear	2700K	310lm
KFLM02GLF-CLR	2W	Golf	E14 B22 E27	Clear	2700K	200lm
KFLM04GLF-CLR	4W	Golf	E14 B22 E27	Clear	2700K	400lm

Product Code

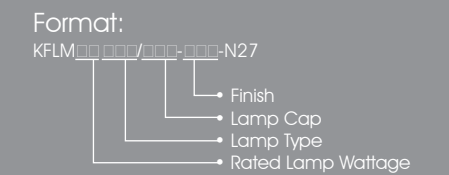

Code: KFLM02CND/B15-CLR-N27 KFLM04CND/B15-CLR-N27
KFLM02CND/E14-CLR-N27 KFLM04CND/E14-CLR-N27
KFLM02CND/B22-CLR-N27 KFLM04CND/B22-CLR-N27
KFLM02CND/E27-CLR-N27 KFLM04CND/E27-CLR-N27

KFLM02BTP/E14-CLR-N27 KFLM04BTP/E14-CLR-N27
KFLM02BTP/B22-CLR-N27 KFLM04BTP/B22-CLR-N27
KFLM02BTP/E27-CLR-N27 KFLM04BTP/E27-CLR-N27

KFLM02TWT/E14-CLR-N27 KFLM04TWT/E14-CLR-N27
KFLM02TWT/B22-CLR-N27 KFLM04TWT/B22-CLR-N27
KFLM02TWT/E27-CLR-N27 KFLM04TWT/E27-CLR-N27

KFLM02GLF/E14-CLR-N27 KFLM04GLF/E14-CLR-N27
KFLM02GLF/B22-CLR-N27 KFLM04GLF/B22-CLR-N27
KFLM02GLF/E27-CLR-N27 KFLM04GLF/E27-CLR-N27

Dimensions

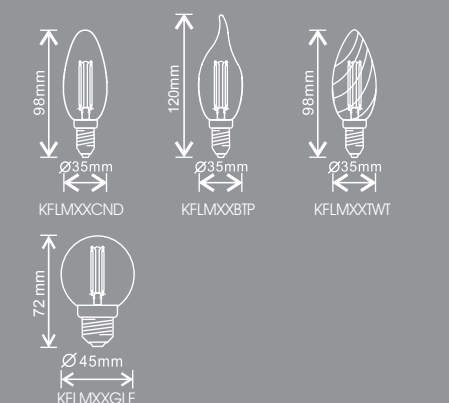



Order Code	Power	Type	Cap	Finish	Colour	Lumen
KFLM04GLS-GLD	4W	GLS	B22 E27	Coated	2700K	380lm
KFLM02G100-GLD	2W	Globe	B22 E27	Coated	2700K	150lm
KFLM04G100-GLD	4W	Globe	B22 E27	Coated	2700K	380lm
KFLM02G125-GLD	2W	Globe	B22 E27	Coated	2700K	210lm
KFLM04G125-GLD	4W	Globe	B22 E27	Coated	2700K	400lm
KFLM02ST64-GLD	2W	ST64	B22 E27	Coated	2700K	140lm
KFLM04ST64-GLD	4W	ST64	B22 E27	Coated	2700K	380lm

Product Code

Code:

KFLM04GLS/B22-GLD-N27
KFLM04GLS/E27-GLD-N27

KFLM02G100/B22-GLD-N27 KFLM04G100/B22-GLD-N27
KFLM02G100/E27-GLD-N27 KFLM04G100/E27-GLD-N27

KFLM02G125/B22-GLD-N27 KFLM04G125/B22-GLD-N27
KFLM02G125/E27-GLD-N27 KFLM04G125/E27-GLD-N27

KFLM02ST64/B22-GLD-N27 KFLM04ST64/B22-GLD-N27
KFLM02ST64/E27-GLD-N27 KFLM04ST64/E27-GLD-N27

Dimensions

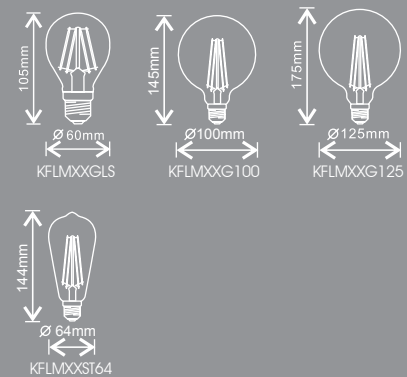

Decor Candle and Golf

Kosnic's Home range of LED products brings the energy saving capabilities of LED technology to the home. The décor candle and golf range is both beautiful and functional, giving a quality of light that creates inviting living spaces while offering lamps that deliver huge energy savings. The range also offers a variety of metallic colour options and shapes to compliment chandeliers and decorative schemes. The lamps can quickly replace traditional incandescent lamps in domestic and hospitality lighting applications and once in place rapid payback is achieved.



Order Code	Power	Cap	Finish	Type	Colour	Lumen
KDIM04CND (Dimmable)	4W	B22 E14 E27	Silver	Candle	2700K	300lm
KTC04CND (Non-Dimmable)	4W	B22 E14 E27	Silver	Candle	2700K	300lm
KDIM5.5CND (Dimmable)	5.5W	B15 B22 E14 E27	Silver Brass Bronze	Candle	2700K	360lm
KTC5.5CND (Non-Dimmable)	5.5W	B15 B22 E14 E27	Silver Brass Bronze	Candle	2700K	360lm
KDIM5.5GLF (Dimmable)	5.5W	B22 E14 E27	Silver	Golf	2700K	360lm
KTC5.5GLF (Non-Dimmable)	5.5W	B22 E14 E27	Silver	Golf	2700K	360lm

* Refer to website for dimmer compatibility



High efficiency of up to 75lm/W, save up to 85% energy



High efficiency low power SMD LED arrays



High CRI over 80Ra



Mains dimmable*



Long life of 30,000h

Product Code

Format:

K- - - - - / - - - - - -N27
 ↳ Finish
 ↳ Lamp Cap
 ↳ Lamp Type
 ↳ Rated Lamp Wattage
 ↳ Dimmable/Non-Dimmable

Code:

KDIM04CND/B22-SLV-N27 KTC04CND/B22-SLV-N27
 KDIM04CND/E14-SLV-N27 KTC04CND/E14-SLV-N27
 KDIM04CND/E27-SLV-N27 KTC04CND/E27-SLV-N27

KDIM5.5CND/B15-SLV-N27 KTC5.5CND/B15-SLV-N27
 KDIM5.5CND/B15-BAS-N27 KTC5.5CND/B15-BAS-N27
 KDIM5.5CND/B15-BOZ-N27 KTC5.5CND/B15-BOZ-N27
 KDIM5.5CND/B22-SLV-N27 KTC5.5CND/B22-SLV-N27
 KDIM5.5CND/E14-SLV-N27 KTC5.5CND/E14-SLV-N27
 KDIM5.5CND/E14-BAS-N27 KTC5.5CND/E14-BAS-N27
 KDIM5.5CND/E14-BOZ-N27 KTC5.5CND/E14-BOZ-N27
 KDIM5.5CND/E27-SLV-N27 KTC5.5CND/E27-SLV-N27

KDIM5.5GLF/E14-SLV-N27 KTC5.5GLF/E14-SLV-N27
 KDIM5.5GLF/B22-SLV-N27 KTC5.5GLF/B22-SLV-N27
 KDIM5.5GLF/E27-SLV-N27 KTC5.5GLF/E27-SLV-N27

Dimensions

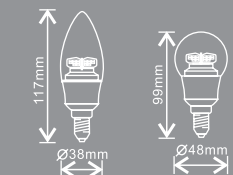



5.5W
Silver Finish
Bent-tip Candle



5.5W
Brass Finish
Bent-tip Candle



5.5W
Bronze Finish
Bent-tip Candle

Order Code	Power	Cap	Finish	Type	Colour	Lumen
KDIM5.5BTP (Dimmable)	5.5W	E14	Silver Brass Bronze	Bent-tip Candle	2700K	360lm
KTC5.5BTP (Non-Dimmable)	5.5W	E14	Silver Brass Bronze	Bent-tip Candle	2700K	360lm



5.5W
Silver Finish
Twisted Candle



5.5W
Brass Finish
Twisted Candle



5.5W
Bronze Finish
Twisted Candle

Order Code	Power	Cap	Finish	Type	Colour	Lumen
KDIM5.5TWT (Dimmable)	5.5W	E14	Silver Brass Bronze	Twisted Candle	2700K	360lm
KTC5.5TWT (Non-Dimmable)	5.5W	E14	Silver Brass Bronze	Twisted Candle	2700K	360lm

Product Code

KDIM5.5BTP/E14-SLV-N27 KTC5.5BTP/E14-SLV-N27
 KDIM5.5BTP/E14-BAS-N27 KTC5.5BTP/E14-BAS-N27
 KDIM5.5BTP/E14-BOZ-N27 KTC5.5BTP/E14-BOZ-N27

Dimensions



Product Code

KDIM5.5TWT/E14-SLV-N27 KTC5.5TWT/E14-SLV-N27
 KDIM5.5TWT/E14-BAS-N27 KTC5.5TWT/E14-BAS-N27
 KDIM5.5TWT/E14-BOZ-N27 KTC5.5TWT/E14-BOZ-N27

Dimensions

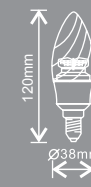

GLS

Kosnic's LED GLS brings the energy saving capabilities of LED technology to the home. The range is both efficient and functional, offering lamps that deliver huge energy savings without compromising on brightness. The lamps can quickly replace incandescent Lamps in general applications, and once in place rapid payback is achieved. Dimmable versions are available. In comparison to CFL lamps, the Kosnic LED GLS also benefits from: instant start; Negligible UV output and are also mercury free.



13.5W 12W 10W
Dimmable
Non-Dimmable
GLS



8W 6W
Dimmable
Non-Dimmable
GLS



6W
Dimmable
GLS

Order Code	Power	Cap	Colour	Lumen
KDIM12GLS (Dimmable)	12W	B22 E27	3000K	1050lm
			4000K	1150lm
			6500K	1150lm
KDIM10GLS (Dimmable)	10W	B22 E27	3000K	800lm
			4000K	810lm
			6500K	810lm
KDIM08GLS (Dimmable)	8W	B22 E27	3000K	720lm
			4000K	730lm
			6500K	730lm
KDIM06GLS (Dimmable)	6W	B22 E27	3000K	440lm
			4000K	500lm
			6500K	500lm
KTC13.5GLS (Non-Dimmable)	13.5W	B22 E27	3000K	1550lm
			4000K	1650lm
			6500K	1650lm
KTC12GLS (Non-Dimmable)	12W	B22 E27	3000K	1100lm
			4000K	1200lm
			6500K	1200lm
KTC10GLS (Non-Dimmable)	10W	B22 E27	3000K	950lm
			4000K	970lm
			6500K	980lm
KTC08GLS (Non-Dimmable)	8W	B22 E27	3000K	750lm
			4000K	770lm
			6500K	780lm
KTC06GLS (Non-Dimmable)	6W	B22 E27	3000K	580lm
			4000K	600lm
			6500K	600lm



High efficiency of up to 100lm/W, save up to 90% energy



Premium Samsung low power SMD LED arrays



High CRI over 80Ra



Mains dimmable*



Long life of 30,000h

Product Code

Format:

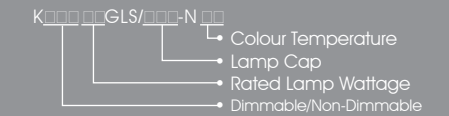

Code:

KDIM12GLS/B22-N30	KDIM12GLS/E27-N30
KDIM12GLS/B22-N40	KDIM12GLS/E27-N40
KDIM12GLS/B22-N65	KDIM12GLS/E27-N65
KDIM10GLS/B22-N30	KDIM10GLS/E27-N30
KDIM10GLS/B22-N40	KDIM10GLS/E27-N40
KDIM10GLS/B22-N65	KDIM10GLS/E27-N65
KDIM08GLS/B22-N30	KDIM08GLS/E27-N30
KDIM08GLS/B22-N40	KDIM08GLS/E27-N40
KDIM08GLS/B22-N65	KDIM08GLS/E27-N65
KDIM06GLS/B22-N30	KDIM06GLS/E27-N30
KDIM06GLS/B22-N40	KDIM06GLS/E27-N40
KDIM06GLS/B22-N65	KDIM06GLS/E27-N65
KTC13.5GLS/B22-N30	KTC13.5GLS/E27-N30
KTC13.5GLS/B22-N40	KTC13.5GLS/E27-N40
KTC13.5GLS/B22-N65	KTC13.5GLS/E27-N65
KTC12GLS/B22-N30	KTC12GLS/E27-N30
KTC12GLS/B22-N40	KTC12GLS/E27-N40
KTC12GLS/B22-N65	KTC12GLS/E27-N65
KTC10GLS/B22-N30	KTC10GLS/E27-N30
KTC10GLS/B22-N40	KTC10GLS/E27-N40
KTC10GLS/B22-N65	KTC10GLS/E27-N65
KTC08GLS/B22-N30	KTC08GLS/E27-N30
KTC08GLS/B22-N40	KTC08GLS/E27-N40
KTC08GLS/B22-N65	KTC08GLS/E27-N65
KTC06GLS/B22-N30	KTC06GLS/E27-N30
KTC06GLS/B22-N40	KTC06GLS/E27-N40
KTC06GLS/B22-N65	KTC06GLS/E27-N65

Dimensions

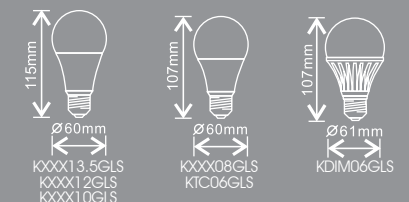

* Refer to website for dimmer compatibility

GX53, G9, G4

Kosnic's Home range of GX53, G9, G4 and R7s lamps are an ideal low energy replacement of corresponding halogen lamps that are often found in domestic applications. This range of products are compact in size and offer huge energy saving. Once in place rapid payback is achieved.



Order Code	Power	Cap	Colour	Lumen
KLED07DSK	7W	GX53	3000K 6500K	650lm(540lm)* 690lm(570lm)*
KLED05DSK	5W	GX53	3000K 6500K	500lm(410lm)* 540lm(450lm)*
KLED03DSK	3W	GX53	3000K 6500K	240lm 280lm
KLED07LNR	7W	R7S	6500K	680lm
KLED3.5CPL	3.5W	G9	3000K 6500K	310lm 320lm
KTC02CPL	2W	G9	3000K 6000K	90lm 100lm
KLED1.5CPL	1.5W	G4	3000K	140lm
KLED1.2CPL	1.2W	G4	3000K	80lm

* Total lumen (lumen measured in 90°/120° Cone)



High efficiency of up to 100lm/W, save up to 90% energy



High efficiency low-power SMD LED and COB LED chips



High CRI over 80Ra



Long life of 30,000h

Product Code

Format:

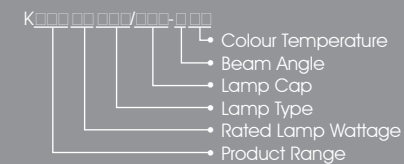

Code:

KLED07DSK/GX53-W30 KLED05DSK/GX53-W30
KLED07DSK/GX53-W65 KLED05DSK/GX53-W65
KLED03DSK/GX53-W30 KLED07LNR/R7S-W65
KLED03DSK/GX53-W65
KLED3.5CPL/G9-N30 KTC02CPL/G9-N30
KLED3.5CPL/G9-N65 KTC02CPL/G9-N60
KLED1.5CPL/G4-N30 KLED1.2CPL/G4-N30

Dimensions

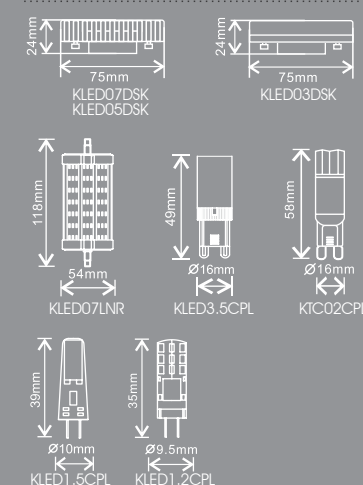

ReonLED (GLS, Candle and Golf)

The Reon range from Kosnic is a selected line of 20,000 energy saving retrofit LED lamps, which are reliable, affordable and easy to install, Reon LEDs surpass the high quality standards that home owners and lighting professionals demand for lower cost applications.

This range includes the popular GLS, Candle and Golf.



6W 5W
4W 3W
Opal
Candle



5W 4W 3W
Clear
Candle

Order Code	Power	Type	Cap	Colour	Lumen
RLCND06	6W	Opal Candle	B22 E14 E27	3000K	540lm
RDCND05 (Dimmable)	5W	Opal Candle	B22 E14 E27	3000K	400lm
RLCND05	5W	Opal Candle	B15 B22 E14 E27	3000K 4000K 6500K	400lm 420lm 440lm
RLCND04	4W	Opal Candle	B22 E14 E27	3000K 4000K 6500K	320lm 340lm 360lm
RLCND03	3W	Opal Candle	B22 E14 E27	3000K	240lm
RLCCN05	5W	Clear Candle	B22 E14 E27	3000K	330lm
RLCCN04	4W	Clear Candle	B22 E14 E27	3000K	290lm
RLCCN03	3W	Clear Candle	B22 E14 E27	3000K 6500K	250lm 260lm



High efficiency of up to 90lm/W, save up to 90% energy



High efficiency low power SMD LED and COB LED chips



High CRI over 80Ra



Long life of 20,000h

Product Code

Format:

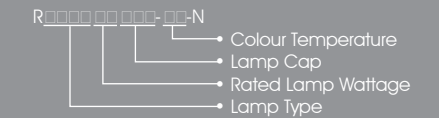

Code:

RLCND06B22-30-N RDCND05B22-30-N
RLCND06E14-30-N RDCND05E14-30-N
RLCND06E27-30-N RDCND05E27-30-N
RLCND05B15-30-N RLCND05B22-40-N
RLCND05B22-30-N RLCND05E14-40-N
RLCND05E14-30-N RLCND05E27-40-N
RLCND05E27-30-N
RLCND05B22-65-N RLCND04B22-30-N
RLCND05E14-65-N RLCND04E14-30-N
RLCND05E27-65-N RLCND04E27-30-N
RLCND04B22-40-N RLCND04B22-65-N
RLCND04E14-40-N RLCND04E14-65-N
RLCND04E27-40-N RLCND04E27-65-N
RLCND03B22-30-N RLCCN05B22-30-N
RLCND03E14-30-N RLCCN05E14-30-N
RLCND03E27-30-N RLCCN05E27-30-N
RLCCN04B22-30-N RLCCN03B22-30-N
RLCCN04E14-30-N RLCCN03E14-30-N
RLCCN04E27-30-N RLCCN03E27-30-N
RLCCN03B22-65-N
RLCCN03E14-65-N
RLCCN03E27-65-N

Dimensions

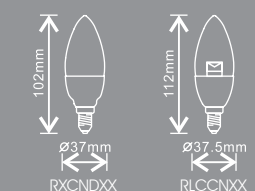



Order Code	Power	Type	Cap	Colour	Lumen
RLGLF05	5W	Golf	B22 E14 E27	3000K 6500K	400lm 440lm
RLGLF04	4W	Golf	B22 E14 E27	3000K	320lm
RLGLS11	11W	GLS	B22 E27	3000K	920lm
RLGLS09	9W	GLS	B22 E27	3000K 4000K 6500K	760lm 800lm 840lm
RLGLS07	7W	GLS	B22 E27	3000K 4000K 6500K	600lm 620lm 640lm
RLGLS05	5W	GLS	B22 E27	3000K	420lm
RLGLB11	11W	Globe	B22 E27	3000K	1000lm

Product Code

Code:

RLGLF05B22-30-N
RLGLF05E14-30-N
RLGLF05E27-30-N

RLGLF04B22-30-N
RLGLF04E14-30-N
RLGLF04E27-30-N

RLGLS11B22-30-N
RLGLS11E27-30-N

RLGLS09B22-40-N
RLGLS09E27-40-N

RLGLS07B22-30-N
RLGLS07E27-30-N

RLGLS07B22-65-N
RLGLS07E27-65-N

RLGLB11B22-30-N
RLGLB11E27-30-N

Dimensions

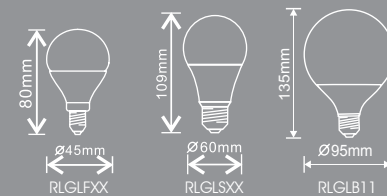

ReonLED (Reflectors)

The Reon range from Kosnic is a selected line of energy saving retrofit LED lamps which are reliable, affordable and easy to install. Reon LEDs surpass the high quality standards that home owners and lighting professionals demand for lower cost applications.

The reflector range includes the popular GU10, R50, R63 and R80.



Order Code	Power	Type	Cap	Beam Angle	Colour	Lumen*
RLCOB05 (Non-Dimmable)	5W	PAR16	GU10	65°	3000K 6500K	380lm(350lm) 400lm(370lm)
RDCOB05 (Dimmable)	5W	PAR16	GU10	65°	3000K 6500K	380lm(350lm) 400lm(370lm)
RLEC04	4W	PAR16	GU10	100°	3000K 6500K	300lm(240lm) 320lm(260lm)
RLEC03	3W	PAR16	GU10	100°	3000K 6500K	250lm(205lm) 270lm(225lm)
RLR5004	4W	R50	E14	75°	3000K	280lm(190lm)
RLR6306	6W	R63	E27	75°	3000K	420lm(270lm)
RLR8008	8W	R80	E27	75°	3000K	560lm(350lm)

* Total lumen (lumen measured in 90°/120° Cone)



High efficiency of up to 90lm/W, save up to 90% energy



High efficiency low power SMD LED and COB LED chips



High CRI over 80Ra



Long life of 20,000h

Product Code

Format:

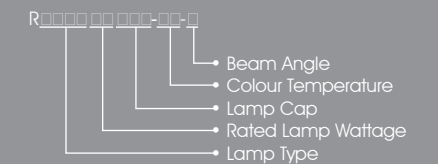

Code:

RLCOB05GU10-30-F RDCOB05GU10-30-F
RLCOB05GU10-65-F RDCOB05GU10-65-F

RLEC04GU10-30-W RLEC03GU10-30-W
RLEC04GU10-65-W RLEC03GU10-65-W

RLR5004E14-30-W RLR6306E27-30-W

RLR8008E27-30-W

Dimensions

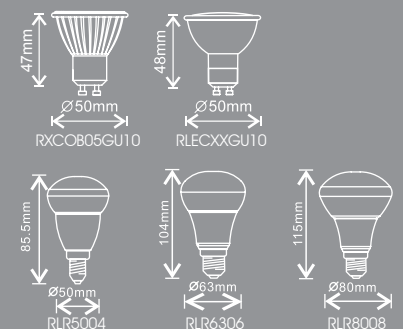

ReonLED (PAR Reflectors)

The Reon range from Kosnic is a selected line of energy saving retrofit LED lamps which are reliable, affordable and easy to install. Reon LEDs surpass the high quality standards that home owners and lighting professionals demand for lower cost applications.

The PAR reflector range includes the popular PAR20, PAR30 and PAR38.



Order Code	Power	Type	Cap	Beam Angle	Colour	Lumen*
RLP2007	7W	PAR20	E27	60°	3000K	500lm(400lm)
RLP3009	9W	PAR30	E27	60°	3000K	670lm(500lm)
RLP3811	11W	PAR38	E27	60°	3000K	800lm(600lm)



High efficiency of up to 90lm/W, save up to 90% energy



High efficiency low power SMD LED and COB LED chips



High CRI over 80Ra



Long life of 20,000h

Product Code

Format:

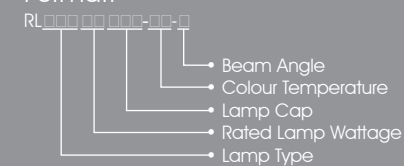

Code:

RLP2007E27-30-F

RLP3009E27-30-F

RLP3811E27-30-F

Dimensions

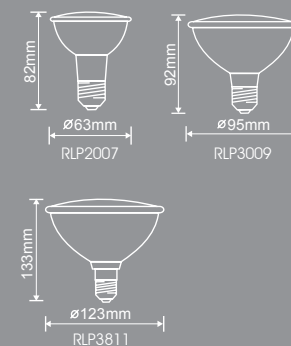

* Total lumen (lumen measured in 90°/120° Cone)

LED DD

Kosnic's range of award winning LED DD lamps takes a fresh approach to functional lighting with a design philosophy offering plug-in emergency packs so that there are no barriers to retrofitting LEDs in commercial fittings. The products bring the energy saving capabilities of LED technology to the commercial environment and the lamps can quickly replace fluorescent DD lamps with little or no rewiring.

The LED DD lamp is compatible with the Kosnic emergency module, which provides power in the event of a cut in the supply and must be wired to the un-switched supply through the un-switched Live terminal. The battery will supply the lamp for over 3 hours at a reduced output.



Order Code	Power	Cap	Beam Angle	Colour	Lumen
KHV14STD	14W	GR10q	120°	4000K	1050lm
KLED18STD	18W	GR10q	120°	2700K	1780lm
				4000K	1880lm
				6500K	1880lm
KLED12STD	12W	GR8 GR10q	120°	2700K	1220lm
				4000K	1320lm
				6500K	1320lm
KLED09STD	9W	GR8 GR10q	120°	4000K	1050lm

Plug-in Emergency Module

Order Code	Output Current	Output Voltage	Battery	Battery Capacity	Battery Discharge Current (Max)
KTC27EME-DD	50mA	20-38Vdc	Samsung Li-Ion KBAT2200	2200mAh	270mA



High efficiency of up to 110lm/W, save up to 57% energy



High efficiency low power SMD LED chips



High CRI over 80Ra



Plug and play emergency module for Maintained / Non-Maintained Emergency conversion



Long life of 30,000h

Product Code

Format:

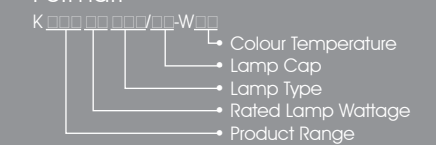

Code:

KHV14STD/4P-W40

KLED18STD/4P-W27 KLED12STD/4P-W27
KLED18STD/4P-W40 KLED12STD/4P-W40
KLED18STD/4P-W65 KLED12STD/4P-W65
KLED12STD/2P-W40

KLED09STD/4P-W40
KLED09STD/2P-W40

Dimensions

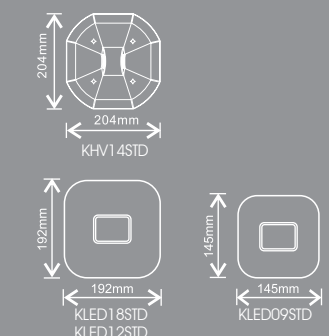

Patented Product



Customer: Cadbury World Experience
 Project: Cadbury's Café Kitchen
 Location: LED retrofit of existing CFLs
 Product: Kosnic 36W Lumi LED Panels

LED

LUMI

COMP

CFL

HALO

Panel

Standard

The Kosnic LED panel offers Edge-Lit technology to achieve constant light across the surface of the luminaire and is an easy-to-retrofit replacement for in-lay ceiling tile fittings with a slim profile of only 8.5mm. Optional surface and suspension mounting kits are available. The standard panels are suitable for amenity lighting of corridors, stairwells, storerooms, transit areas and other utility spaces. This panel can be ordered with ripple free drivers for office or educational applications.

Our LED panel is compatible with the Kosnic emergency module, which provides power in the event of a cut in the supply and must be wired to the un-switched supply through the un-switched live terminal. The battery will supply the panel for over 3 hours at a reduced output.



Order Code	Power	Dimension	Input Current	Finish	Driver	Colour	Lumen
KLED30PNL	30W	595*595mm	137mA	Satin Silver	CYC033SNL091	3000K 4000K 6500K	2900lm 2900lm 3000lm
KLED30PNL-WHT	30W	595*595mm	137mA	White	CYC033SNL091	3000K 4000K 6500K	2900lm 2900lm 3000lm
KLED40PNL	40W	595*595mm	183mA	Satin Silver	CYC050SNL135N (Ripple free)	4000K 6500K	3800lm 3800lm
KLED30PNL0505	30W	495*495mm	137mA	Satin Silver	CYC033SNL091	4000K 6500K	2900lm 3000lm

General Specification

Voltage 220-240Vac 50-60Hz **CRI** >80 **Life Time** 40,000hrs
Power Factor >0.95 **Ambient Temp** -20°C to 50°C
Housing Anodized aluminum **Diffuser** Polycarbonate (TPb) **Protection** Class II, IP44
 (when ceiling recessed mounted)

Options

Add to order code	Description	Component Code	Models
/T	With ripple free driver	CYC033SNL091N	KLED30PNL
/DD	DALI Dimmable, Tridonic TALEXXdriver LCAI 35W 350mA-900mA ECO SR	KPNL-TRO30	KLED30PNL KLED30PNL0505
/DD	DALI Dimmable, Tridonic TALEXXdriver LCAI 55W 900mA-1750mA ECO SR	KPNL-TRO55	KLED40PNL
/AD	1-10V dimmable, 1350mA	CYC060TVC135	KLED40PNL

Accessories

Type	Order Code	Description	Models
Emergency Module	CEC038LIL100N	With Li-Ion battery	All Models

Fixings



Suspended Fixing
KPTPNL/SUS



Surface Mount Kit A
KPTPNL/SMT
An aluminum surface mount enclosure for LED panel and driver



Surface Mount Kit B
KPTPNL/SMT-ECO1
A surface mount low profile bracket for LED panel with driver being placed in the ceiling



High efficiency of up to 107lm/W, save up to 60% energy



Fire resistant polycarbonate diffuser (TPb)



High efficiency 4014 SMD for ultra slim profile



Good glare control with UGR <19



Plug and play emergency module for Maintained / Non-Maintained Emergency conversion



Dimmable Options: DALI and 1-10V



Long life of 40,000h

Product Code

Format:

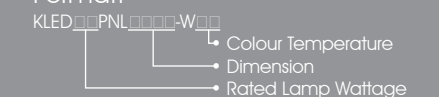

Code:

KLED30PNL-W30 KLED30PNL-W30-WHT
 KLED30PNL-W40 KLED30PNL-W40-WHT
 KLED30PNL-W65 KLED30PNL-W65-WHT
 KLED40PNL-W40 KLED30PNL0505-W40
 KLED40PNL-W65 KLED30PNL0505-W65

Dimensions

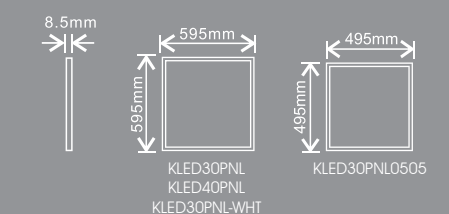

Pro

The Kosnic LED ceiling and wall panel is an easy-to-retrofit replacement for standard ceiling tile fittings. These advanced panels are suitable for all areas, including visually demanding non-transient task areas such as offices and educational premises where users require uniform light to maintain well-being. The Kosnic LED panel offers Edge-Lit technology to achieve constant light across the surface of the luminaire.

The LED panel is compatible with the Kosnic emergency module, which provides power in the event of a cut in the supply and must be wired to the un-switched supply through the un-switched live terminal. The battery will supply the panel for over 3 hours at a reduced output.



Order Code	Power	Dimension	Input Current	Finish	Driver	Colour	Lumen
KLED36PNL	36W	595*595mm	160mA	Satin Silver	CYC050SNL135N (Ripple free)	4000K 6500K	3700lm 3800lm
KLED45PNL	45W	595*595mm	200mA	Satin Silver	CYC050SNL135N (Ripple free)	4000K 6500K	3800lm 4000lm
KLED80PNL	80W	595*1195mm	2*160mA	Satin Silver	2*CYC050SNL135N (Ripple free)	4000K 6500K	6400lm 6600lm
KPNLLS30LT-1203	30W	295*1195mm	137mA	Satin Silver	CYC033SNL091N (Ripple free)	4000K	2900lm
KLED36PNL0303	36W	295*295mm	160mA	Satin Silver	CYC050SNL135N (Ripple free)	4000K	3200lm

General Specification

Voltage 220-240Vac 50-60Hz	CRI >80	Life Time 40,000hrs
Power Factor >0.95	Ambient Temp -20°C to 50°C	
Housing Anodized aluminum	Diffuser Polycarbonate (TPa)	Protection Class II, IP44 (when ceiling recessed mounted)

Options

Add to order code	Description	Component Code	Models
/DD	DALI Dimmable, Tridonic TALEXXdriver LCAI 35W 350mA-900mA ECO SR	KPNL-TRO30	KPNLLS30LT-1203
/DD	DALI Dimmable, Tridonic TALEXXdriver LCAI 55W 900mA-1750mA ECO SR	KPNL-TRO55	KLED36PNL KLED45PNL KLED80PNL KLED36PNL0303
/AD	1-10V dimmable, 1350mA	CYC060TVC135	KLED36PNL KLED45PNL KLED80PNL KLED36PNL0303

Accessories

Type	Order Code	Description	Models
Emergency Module	CEC038LIL100N	Lithium Battery	All Models

Fixings



Suspended Fixing
KPTPNL/SUS



Surface Mount Kit A
KPTPNL/SMT
An aluminum surface mount enclosure for LED panel and driver



Surface Mount Kit B
KPTPNL/SMT-ECO2
A surface mount low profile bracket for LED panel with driver being placed in the ceiling



High efficiency of up to 106lm/W, save up to 60% energy



Ultra thin edge



Fire resistant polycarbonate diffuser (TPa)



Premium Samsung SMDs for superior CCT consistency



Good glare control with UGR <19



Plug and play emergency module for Maintained / Non-Maintained Emergency conversion



Dimmable Options: DALI and 1-10V



Long life of 40,000h

Product Code

Format:



Code:

KLED36PNL-W40	KLED45PNL-W40
KLED36PNL-W65	KLED45PNL-W65
KLED80PNL-W40	KPNLLS30LT-1203-W40
KLED80PNL-W65	
KLED36PNL0303-W40	
KLED36PNL0303-W65	

Dimensions

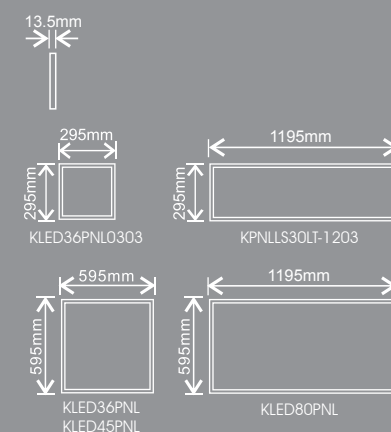

Twin Bar (with PIR option)

The Kosnic LED Twin Bar panel has a unique design with two Edge-Lit LED "bars" sitting on either side of the panel. An optional PIR sensor can be mounted to the center plate. Via remote control the sensor can be programmed to control the panel's light output based on occupation and natural light detection. This product is suitable for amenity lighting of corridors, stairwells, storerooms, transit areas and other utility spaces. The panels are also available with advanced two-stage ripple-free drivers for visually demanding non-transient task areas such as offices and educational premises where users require high quality lighting to maintain well-being.

This luminaire is compatible with Kosnic's Emergency Module.



Order Code	Type	Power	Dimension	Input Current	Finish	Driver	Colour	Lumen
KTWB30PNL	Standard	30W	595*595mm	137mA	White	CYC033SNL091	4000K 6500K	3200lm
KTWB40PNL	Standard	40W	595*595mm	183mA	White	CYC050SNL135	4000K 6500K	3600lm

General Specification

Voltage 220-240Vac 50-60Hz	CRI >80	Life Time 40,000hrs
Power Factor >0.95	Ambient Temp -20°C to 50°C	
Housing Anodized aluminum	Diffuser Polycarbonate (TPb)	Protection Class II, IP20

Options

Add to order code	Description	Component Code	Models
/T	With ripple free driver	CYC033SNL091N	KTWB30PNL
/T	With ripple free driver	CYC050SNL135N	KTWB40PNL
/DD	DALI Dimmable, Tridonic TALEXXdriver LCAI 35W 350mA-900mA ECO SR	KPNL-TRO30	KTWB30PNL
/DD	DALI Dimmable, Tridonic TALEXXdriver LCAI 55W 900mA-1750mA ECO SR	KPNL-TRO55	KTWB40PNL
/AD	1-10V dimmable, 350-1050mA	CYC050TVC35-105	KTWB30PNL
/AD	1-10V dimmable, 1350mA	CYC060TVC135	KTWB40PNL

Accessories

Type	Order Code	Description	Models
Emergency Module	CEC038LIL100N	With Li-Ion battery	All Models
Sensor	EBMHS-PRM-SA-C	On/off output Provided by CP Electronics	KTWB30PNL
Sensor	EBMHS-AD-SA-C	1-10V output Provided by CP Electronics	KTWB30PNL/AD

Fixings



Suspended Fixing
KPTPNL/SUS



Surface Mount Kit A
KPTPNL/SMT
An aluminum surface mount enclosure for LED panel and driver

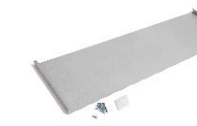

Surface Mount Kit B
KPTPNL/SMT-ECO1
A surface mount low profile bracket for LED panel with driver being placed in the ceiling



High efficiency of up to 107lm/W, save up to 60% energy



Fire resistant polycarbonate diffuser (TPb)



High efficiency 4014 SMD for ultra slim profile



Good glare control with UGR <19



PIR and lux sensor



Plug and play emergency module for Maintained / Non-Maintained Emergency conversion



Dimmable Options: DALI and 1-10V



Long life of 40,000h

Product Code

Format:

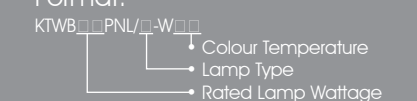

Code:

KTWB30PNL-W40	KTWB40PNL-W40
KTWB30PNL-W65	KTWB40PNL-W65

Dimensions

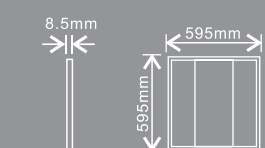

Pyramid

The distinctive Pyramid LED panel luminaire offers a contemporary alternative to standard panel luminaires. The sharp lines created by the pyramid effect reflector design reveal a central 300mm square recessed light source, delivering uniform light output with exceptional lumen efficiency.

This luminaire is compatible with Kosnic's Emergency Module.



Order Code	Power	Input Current	Finish	Driver	Colour	Lumen
KPYD36PNL	36W	160mA	White	CYC050TNL135	4000K	3300lm

General Specification

Voltage 220-240Vac 50-60Hz **CRI** >80 **Life Time** 40,000hrs
Power Factor >0.95 **Ambient Temp** -20°C to 50°C
Housing Zinc coated sheet steel **Diffuser** Polycarbonate **Protection** Class II, IP20

Options

Add to order code	Description	Component Code	Models
/DD	DALI Dimmable, Tridonic TALEXXdriver LCAI 55W 900mA-1750mA ECO SR	KPNL-TRO55	All Models
/AD	1-10V dimmable, 1350mA	CYC060TVC135	All Models

Accessories

Type	Order Code	Description	Models
Emergency Module	CEC038LIL100N	With Li-Ion battery	All Models



High efficiency of up to 107lm/W, save up to 60% energy



Fire resistant polycarbonate diffuser (TPb)



High efficiency 4014 SMD for ultra slim profile



Good glare control with UGR <17



Plug and play emergency module for Maintained / Non-Maintained Emergency conversion



Dimmable Options: DALI and 1-10V



Long life of 40,000h

Product Code

Code:
KPYD36PNL-W40

Dimensions

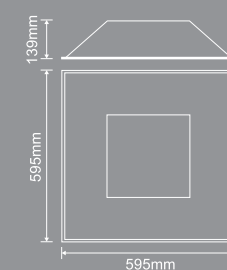

Surface-Mount Circular Panel

This LED circular panel is designed for surface installation on walls and ceilings. With Edge-Lit technology, it produces constant light across the surface of the luminaire. There are three sizes available, 400mm, 500mm and 600mm in diameter. It is ideal for interior applications such as corridors, hotel rooms, lobbies, offices and educational premises where users require uniform light to maintain well-being.

This luminaire is compatible with Kosnic's Emergency Module.



25W



30W



35W

Order Code	Power	Input Current	Finish	Colour	Lumen
KPNLLS25CS	25W	280mA	White	4000K	2100lm
KPNLLS30CS	30W	200mA	White	4000K	2200lm
KPNLLS35CS	35W	390mA	White	4000K	2940lm

General Specification

Voltage 220-240Vac 50-60Hz **CRI** >80 **Life Time** 40,000hrs
Power Factor >0.95 **Ambient Temp** -20°C to 50°C
Housing Anodized aluminum **Diffuser** Polycarbonate (TPb) **Protection** Class II, IP20

Accessories

Type	Order Code	Description	Models
Emergency Module	CEC038LIL100N	With Li-Ion battery	All Models



High efficiency of up to 107lm/W, save up to 60% energy



Fire resistant polycarbonate diffuser (TPb)



Highly efficiency low power SMD



Good glare control with UGR <19



Maintained / Non-Maintained Emergency option



Long life of 40,000h

Product Code

Code:
KPNLLS25CS-W40 KPNLLS30CS-W40
KPNLLS35CS-W40

Dimensions

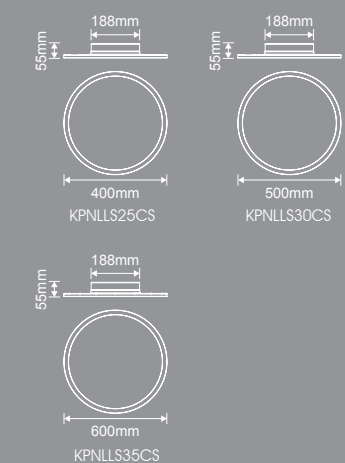

IP65 Utility Bulkhead

The IP65 utility bulkhead luminaire is suitable for both interior and exterior use and is easy to surface mount on the wall or ceiling. They are designed to house the complete range of Kosnic LED DD lamps, offering a choice of even more power outputs with microwave sensor and corridor function dimming. There is also the option of an integrated LED tray, which is designed for easy installation and lower cost. This range of products are an ideal solution to lighting corridors, staircases, security zones and public spaces.



Standard (for Kosnic LED DD lamps only)

Order Code	Protection	Finish	Emergency Conversion Time	Emergency Operating Time	Compatible Lamps
KBHDDC1S65	Class II IP65 IK10	White	/	/	KLED09STD KLED12STD KLED18STD KLED12CRD KLED18CRD
KBHDDC1S65/E	Class II IP65 IK10	White	1 Second	3 Hours	KLED09STD KLED12STD KLED18STD KLED12CRD KLED18CRD

Integrated

Order Code	Power	Protection	Finish	Emergency Conversion Time	Emergency Operating Time	Colour	Lumen
KBHCT14C1S65	14W	Class II IP65 IK10	White	/	/	4000K	1030lm
KBHCT14C1S65/E	14W	Class II IP65 IK10	White	1 Second	3 Hours	4000K	1030lm

General Specification

Voltage 220-240Vac 50-60Hz **Housing** Polycarbonate **Diffuser** Polycarbonate
Ambient Temp -20°C to 40°C **Lamp Base** 4pin **Protection** Class II, IP65, IK10

-  Fire resistant polycarbonate body and diffuser
-  Protection against dust and low pressure water jet
-  Impact resistance rating of IK10
-  Microwave sensor and corridors function available
-  Maintained / Non-Maintained Emergency option
-  Long life of 40,000h (Integrated LED)

Product Code

Format:
 KBH□□□C1S65/□□□□□□
 → Colour Temperature
 → Beam Angle
 → Emergency
 → Rated Lamp Wattage
 → Lamp Type

Code:
 KBHDDC1S65 KBHCT14C1S65-W40
 KBHDDC1S65/E KBHCT14C1S65/E-W40

Dimensions

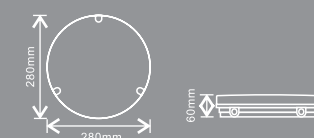

IP65 Polo Bulkhead

This IP65 Polo bulkhead luminaire is suitable for both interior and exterior use and is easy to surface mount on the wall or ceiling. They are designed to house the complete range of Kosnic LED DD lamps, offering a choice of even more power outputs with microwave sensor and corridor function dimming. There is also the option of an integrated LED tray, which is designed for easy installation and lower cost. It also offers different options of decorative trim. This range of products is an ideal solution to lighting corridors, staircases, security zones and public spaces.



Standard (for Kosnic LED DD lamps only)

Order Code	Protection	Finish	Emergency Conversion Time	Emergency Operating Time	Compatible Lamps
KBHDDC2S65	Class II IP65 IK10	White Brass Chrome	/	/	KLED09STD KLED12STD KLED18STD KLED12CRD KLED18CRD
KBHDDC2S65/E	Class II IP65 IK10	White Brass Chrome	1 Second	3 Hours	KLED09STD KLED12STD KLED18STD KLED12CRD KLED18CRD

Integrated

Order Code	Power	Protection	Finish	Emergency Conversion Time	Emergency Operating Time	Colour	Lumen
KBHCT14C2S65	14W	Class II IP65 IK10	White Brass Chrome	/	/	4000K	950lm
KBHCT14C2S65/E	14W	Class II IP65 IK10	White Brass Chrome	1 Second	3 Hours	4000K	950lm

General Specification

Voltage 220-240Vac 50-60Hz **Housing** Polycarbonate **Diffuser** Polycarbonate
Ambient Temp -20°C to 40°C **Lamp Base** 4pin **Protection** Class II, IP65, IK10

-  Fire resistant polycarbonate body and diffuser
-  Protection against dust and low pressure water jet
-  Impact resistance rating of IK10
-  Microwave sensor and corridors function available
-  Maintained / Non-Maintained Emergency option
-  Long life of 40,000h (Integrated LED)

Product Code

Format:
 KBH□□□C2S65/□□□□□□
 → Finish
 → Colour Temperature
 → Beam Angle
 → Emergency
 → Rated Lamp Wattage
 → Lamp Type

Code:
 KBHDDC2S65-WHT KBHDDC2S65/E-WHT
 KBHDDC2S65-BAS KBHDDC2S65/E-BAS
 KBHDDC2S65-CHM KBHDDC2S65/E-CHM

KBHCT14C2S65-W40-WHT
 KBHCT14C2S65-W40-BAS
 KBHCT14C2S65-W40-CHM

KBHCT14C2S65/E-W40-WHT
 KBHCT14C2S65/E-W40-BAS
 KBHCT14C2S65/E-W40-CHM

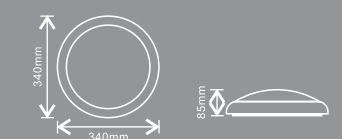

Dimensions



LED Wall Pack

The LED Wall Pack has a die-cast aluminum base and a polycarbonate opal diffuser. It is suited for commercial and industrial applications such as vehicle access areas, pedestrian lighting and perimeter lighting.



-  Diecast aluminum base and polycarbonate diffuser
-  Highly efficiency low power SMD
- IP65** Protection against dust and low pressure water jet
- IK08** Impact resistance rating of IK08
-  Long life of 40,000h

Order Code	Power	Protection	Colour	Lumen
KBHLS50QS65	50W	Class I IP65 IK08	5000K	4400lm

General Specification

Voltage 220-240Vac 50-60Hz **CRI** >80 **Life Time** 40,000hrs
Housing Diecast Aluminum **Diffuser** Polycarbonate **Protection** Class I, IP65, IK08
Ambient Temp -20°C to 40°C

Product Code

Code:
KBHLS50QS65-W50

Dimensions

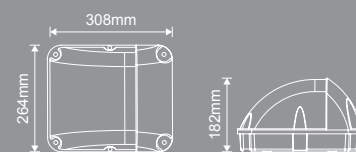

Fire Rated Downlight

These fire rated downlight fittings are rated to 60 minutes, and accommodate any Kosnic retrofit GU10 lamp. With a choice of white, chrome or a silver finish, the fitting will look stylish in any application, room or building space. The patented design enhances airflow through the can, allowing the lamp to run cooler and therefore last longer.



-  steel body
-  Cut-out 68mm
-  Void 165mm
-  Fire Rating 60 minutes



White



Silver



Chrome

Order Code	Protection	Lamp Type	Max Power	Fire Rating	Cut-out
KFDLGU10F	Class II IP20	GU10	50W	60 minutes	68mm

Product Code

Code:
KFDLGU10F-WHT
KFDLGU10F-SLV
KFDLGU10F-CHM

Dimensions

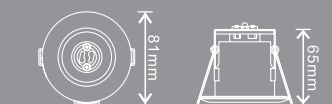

Compact Design with Enhanced Air Cooling

Intumescent Pad

Sits between the back plate and the GU10 Lamp holder. In the case fire, it expands and closes the ventilation window.

Ventilation Window

Large circular opening at the side of the fitting maximise the airflow volume.

Chimney Effect

The canister with two openings and heat source being located at lower half of the can creates Chimney Effect for enhanced airflow.

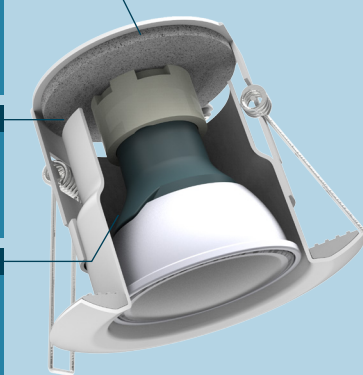

Vertical air path

Chimney effect created to enhance the vertical air flow

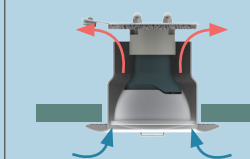

Horizontal air path

Unlike other fire rated down light with side opening, it allows air to flow in and out the fitting for the side.

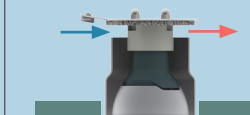





Fire Rated
Downlight

MagFit Fire Rated Downlight

These fire rated downlight fittings are rated to 60 minutes, and accommodate any Kosnic retrofit GU10 lamp. The novel design (patent pending) of the interchangeable bezel, allows the bezels to be magnetically attached to the fitting. The interchangeable bezels come in a choice of white, chrome or silver finish, as well as options of IP20 or IP44 ratings. Magnetic structure of the fitting has patented design to enhance airflow through the can, allowing the lamp to run cooler and therefore last longer.



-  Powder coated steel body
-  Cut-out 73mm
-  Void 165mm
-  Fire Rating 60 minutes

Magnetic IP20/IP44 interchangeable bezel



- IP20
Silver & Chrome
KPT-BZPK20-SC
- IP44
White
KPT-BZ44-WHT
- IP44
Silver
KPT-BZ44-SLV
- IP44
Chrome
KPT-BZ44-CHM

Order Code	Protection	Lamp Type	Max Power	Fire Rating	Cut-out
KFDL07F1-WHT	Class II IP20 / IP44	GU10	7W	60 minutes	73mm

White IP20 bezel as standard

Magnetic Interchangeable Front Bezel (IP20 & IP44)

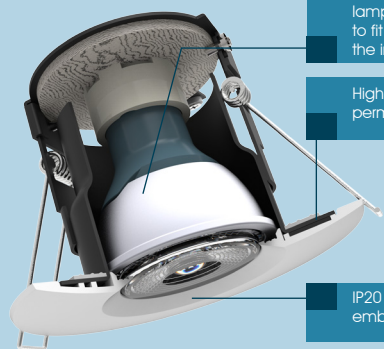

The Lens of HaloLED GU10 lamps is specifically designed to fit the front opening of the interchangeable bezel

High temperature permanent magnets

IP20 Magnetic bezel with embedded magnets

The IP44 bezel has a front glass fixed with silicon adhesive to seal the front opening.

Positioning of LED GU10 Lamp

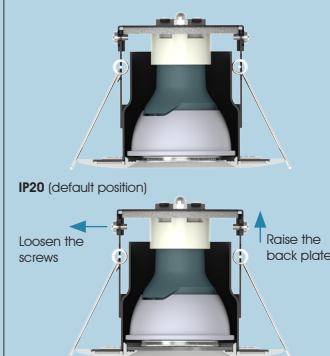









For IP44 bezel, the screws on both sides of the fitting need to be loosened. The back plate is pulled back, so that the LED GU10 Lamp sits back into the fitting allowing space for the front glass of the bezel.

MagFit LED Fire Rated Downlight

The MagFit fire rated downlight is rated to 60 minutes and come prefitted with a Kosnic HaloLED GU10. The novel design of the interchangeable bezel offers flexibility for the bezels to be magnetically attached to the fitting (patent pending). The fitting comes with an IP20 white bezel as standard with a choice of additional chrome or silver finishes, as well as options of IP20 or IP44 ratings. The patented structure of the fitting enhances airflow through the can, allowing the lamp to run cooler and therefore last longer.

Prefitted with
HaloLED GU10 Lamps

-  High efficiency of up to 92lm/W, save up to 90% energy
-  Chip on Board (COB) for the perfect halogen look
-  High CRI over 80Ra
-  Mains dimmable**
-  Powder coated steel body
-  Cut-out 73mm
-  Void 100mm
-  Fire Rating 60 minutes
-  Long life of 35,000h

Magnetic IP20/IP44 interchangeable bezel



- IP20
Silver & Chrome
KPT-BZPK20-SC
- IP44
White
KPT-BZ44-WHT
- IP44
Silver
KPT-BZ44-SLV
- IP44
Chrome
KPT-BZ44-CHM

Order Code	Power	Lamp Type	Colour	Lumen*
KFDL07F1-WHT/D (Dimmable)	7W	HaloLED GU10	2700K 5000K	500lm(440lm) 550lm(490lm)
KFDL06F1-WHT (Non-Dimmable)	6W	HaloLED GU10	2700K 5000K	485lm(425lm) 535lm(475lm)
KFDL05F1-WHT/D (Dimmable)	5W	HaloLED GU10	2700K	430lm(400lm)
KFDL05F1-WHT (Non-Dimmable)	5W	HaloLED GU10	2700K	430lm(400lm)

White IP20 bezel as standard

General Specification

- Voltage** 220-240Vac 50-60Hz
- Beam Angle** 36°
- Fire Rating** 60 minutes
- CRI** >80
- Cut-out** 73mm
- Protection** Class II, IP20 / IP44
- Life Time** 35,000hrs
- Ambient** -20°C to 50°C

* Total lumen (lumen measured in 90°/120° Cone)
** Refer to website for dimmer compatibility

Product Code

Code:
KFDL07F1-WHT

KPT-BZPK20-SC

KPT-BZ44-WHT
KPT-BZ44-SLV
KPT-BZ44-CHM

Dimensions

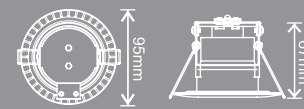

Product Code

Code:
KFDL07F1-S27-WHT/D KFDL06F1-S27-WHT
KFDL07F1-S50-WHT/D KFDL06F1-S50-WHT

KFDL05F1-S27-WHT/D KFDL05F1-S27-WHT

Dimensions

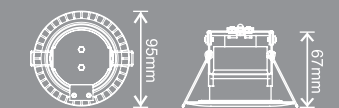

HaloLED Downlight

The HaloLED down lights use a unique built-in LED lens and COB (Chip on Board) technology to replicate the effect of halogen down lights, making them the perfect LED luminaire replacement. Colour finishes are available in white, chrome or silver, offering high lumen efficiency and long life operation.



Fixed



White



Silver



Chrome

Order Code	Power	Beam Angle	Cut-out	Driver	Colour	Lumen
KSDLLC08FF (Non-Dimmable)	8W	36°	65mm	CYC008SNL018N (Ripple free)	2700K	460lm
					4000K	470lm
					6500K	520lm
KSDLLC08FF/DIM (Dimmable)	8W	36°	65mm	CYC008STL018N (Ripple free)	2700K	490lm
					4000K	500lm
					6500K	560lm

Tilt



White



Silver



Chrome

Order Code	Power	Beam Angle	Cut-out	Driver	Colour	Lumen
KSDLLC08TF (Non-Dimmable)	8W	36°	65mm	CYC008SNL018N (Ripple free)	2700K	460lm
					4000K	470lm
					6500K	520lm
KSDLLC08TF/DIM (Dimmable)	8W	36°	65mm	CYC008STL018N (Ripple free)	2700K	490lm
					4000K	500lm
					6500K	560lm

General Specification

Voltage 220-240Vac 50-60Hz	CRI 82	Current 67
Power Factor 0.52	Life Time 40,000hrs	Ambient -20°C to 50°C
Lumen Maintenance Factor at Nominal Lifetime 0.75		Protection Class II

Accessories

Type	Order Code	Description	Models
Emergency Module	KIC10EME-FDL	With Li-Ion battery	All Models



High efficiency of up to 92lm/W, save up to 90% energy



Chip on Board (COB) for the perfect halogen look



High CRI over 80Ra



Plug and play emergency module for Maintained / Non-Maintained Emergency conversion



Long life of 40,000h

Product Code

Format:

KSDLLC08_F/□□□-S□□□□□



Code:

KSDLLC08FF-S27-WHT KSDLLC08FF/DIM-S27-WHT
KSDLLC08FF-S27-MSL KSDLLC08FF/DIM-S27-MSL
KSDLLC08FF-S27-CHM KSDLLC08FF/DIM-S27-CHM

KSDLLC08FF-S40-WHT KSDLLC08FF/DIM-S40-WHT
KSDLLC08FF-S40-MSL KSDLLC08FF/DIM-S40-MSL
KSDLLC08FF-S40-CHM KSDLLC08FF/DIM-S40-CHM

KSDLLC08FF-S65-WHT KSDLLC08FF/DIM-S65-WHT
KSDLLC08FF-S65-MSL KSDLLC08FF/DIM-S65-MSL
KSDLLC08FF-S65-CHM KSDLLC08FF/DIM-S65-CHM

KSDLLC08TF-S27-WHT KSDLLC08TF/DIM-S27-WHT
KSDLLC08TF-S27-MSL KSDLLC08TF/DIM-S27-MSL
KSDLLC08TF-S27-CHM KSDLLC08TF/DIM-S27-CHM

KSDLLC08TF-S40-WHT KSDLLC08TF/DIM-S40-WHT
KSDLLC08TF-S40-MSL KSDLLC08TF/DIM-S40-MSL
KSDLLC08TF-S40-CHM KSDLLC08TF/DIM-S40-CHM

KSDLLC08TF-S65-WHT KSDLLC08TF/DIM-S65-WHT
KSDLLC08TF-S65-MSL KSDLLC08TF/DIM-S65-MSL
KSDLLC08TF-S65-CHM KSDLLC08TF/DIM-S65-CHM

Dimensions



Faceted

Faceted Commercial downlights can be specified to enhance the visual appeal of any modern or contemporary environment. The cosmetic detailing includes a faceted white reflector with a recessed light source that provides an ambient light and good glare control.

8W
3"10W
4"16W
6"24W
8"

Order Code	Power	Beam Angle	Cut-out	Driver	Colour	Lumen
KCDLLS08FR	8W	80°	101mm	CYC009NNL023	4000K	400lm
KCDLLS10FR	10W	80°	111mm	CYC011NNL028	4000K	600lm
KCDLLS16FR	16W	80°	164mm	CYC016SNL037N (Ripple free)	4000K	1100lm
KCDLLS24FR	24W	80°	213mm	CYC026SNL058N (Ripple free)	4000K	1800lm

General Specification

Voltage 220-240Vac 50-60Hz	CRI 85
Power Factor 0.95	Life Time 40,000hrs
Beam Angle 80°	Ambient -20°C to 50°C
Lumen Maintenance Factor at Nominal Lifetime 0.75	Protection Class II, IP40 driver

Options

Add to order code	Description	Component Code	Models
/DD	DALI Dimmable, Tridonic TALEXXdriver LCA 25W 350-1050mA one4all SR PRE	KPNL-TRO25	KCDLLS16FR KCDLLS24FR
/AD	1-10V dimmable, 350-1050mA	CYC050TVC35-105	All Models

Accessories

Type	Order Code	Description	Models
Emergency Module	CEC019LIL050N	With Li-Ion battery	All Models



High efficiency of up to 78lm/W, save energy by over 50% energy



Premium Samsung SMDs for superior CCT consistency



Good glare control with UGR <19



Plug and play emergency module for Maintained / Non-Maintained Emergency conversion



Dimmable Options: DALI and 1-10V



Long life of 40,000h

Product Code

Format:

KCDLLS□FR-W40-WHT

→ Rated Lamp Wattage

Code:

KCDLLS08FR-W40-WHT KCDLLS10FR-W40-WHT

KCDLLS16FR-W40-WHT KCDLLS24FR-W40-WHT

Dimensions

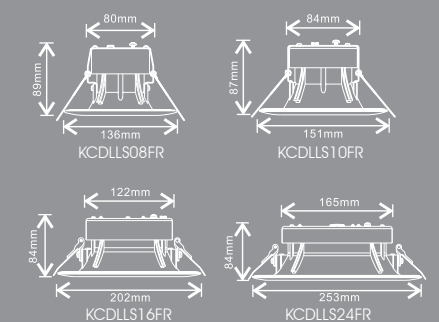

Pro

The LED Commercial Downlights are rated IP65 front and back, and use Driver on Board technology to eliminate the need for an external driver, allowing the complete fitting to be waterproof. They also offer aesthetic visual appearance, low profile heat sink and a recessed light source that provides an ambient light at 10W, 16W or 24W. This product is ideal for swimming pool, bathroom, wet room and kitchen use.



Order Code	Power	Protection	Beam Angle	Cut-out	Colour	Lumen
KPDLHS10CR65	10W	Class II IP65	80°	122mm	4000K	600lm
KPDLHS16CR65	16W	Class II IP65	80°	165mm	4000K	1000lm
KPDLHS24CR65	24W	Class II IP65	80°	212mm	4000K	1800lm

General Specification

Voltage 220-240Vac 50-60Hz **CRI** 85
Power Factor 0.97 **Life Time** 40,000hrs
Beam Angle 80° **Ambient** -20°C to 50°C **Protection** Class II, IP65
Lumen Maintenance Factor at Nominal Lifetime 0.75



High efficiency of up to 78lm/W, save up to 60% energy



Premium Samsung SMDs for superior CCT consistency



IP65 Protection against dust and low pressure water jet



Long life of 40,000h

Product Code

Format:
 KPDLHS□□CR65-W40-WHT
 □□ → Rated Lamp Wattage

Code:
 KPDLHS10CR65-W40-WHT
 KPDLHS16CR65-W40-WHT
 KPDLHS24CR65-W40-WHT

Dimensions

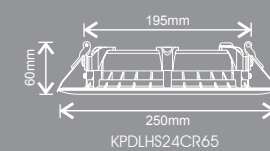
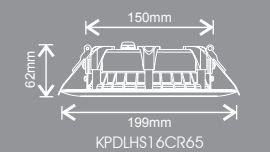
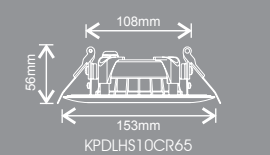

Standard

Standard commercial down lights can be specified to enhance the visual appeal of any modern or contemporary environment. The standard range offers a white trim flush fit frame with low profile heat sink, while the light source provides an ambient light at 10W, 16W or 23W.



Order Code	Power	Protection	Beam Angle	Cut-out	Colour	Lumen
KSDLHS10CF	10W	Class I IP20	105°	116mm	4000K	600lm
KSDLHS16CF	16W	Class I IP20	105°	167mm	4000K	1100lm
KSDLHS23CF	23W	Class I IP20	105°	201mm	4000K	1800lm

General Specification

Voltage 220-240Vac 50-60Hz **CRI** 85
Power Factor 0.52 **Life Time** 30,000hrs
Beam Angle 80° **Ambient** -20°C to 50°C **Protection** Class I, IP20
Lumen Maintenance Factor at Nominal Lifetime 0.75



High efficiency of up to 78lm/W, save energy by over 50% energy



Highly efficiency low power SMD



Long life of 30,000h

Product Code

Format:
 KSDLHS□□CF-W40-WHT
 □□ → Rated Lamp Wattage

Code:
 KSDLHS10CF-W40-WHT
 KSDLHS16CF-W40-WHT
 KSDLHS23CF-W40-WHT

Dimensions

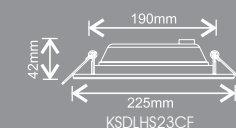
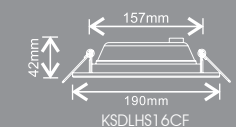
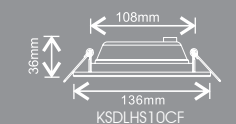

Commercial
Downlight

Circular Panel (Edge-Lit)

This LED downlight consists of a circular edge-lit panel, offering ultra slim profile. It has a high efficiency of 79lm/W. It can be specified to enhance the visual appeal of any modern or contemporary environment.

The LED circular panel is compatible with the Kosnic emergency module, which provides power in the event of a cut in the supply and must be wired to the un-switched supply through the un-switched live terminal. The battery will supply the panel for over 3 hours at a reduced output.



Order Code	Power	Beam Angle	Cut-out	Driver	Colour	Lumen
KPNLLS10CF	10W	110°	140mm	CYC012SNL031N (Ripple free)	4000K	850lm
KPNLLS12CF	12W	110°	160mm	CYC012SNL031N (Ripple free)	4000K	1070lm
KPNLLS18CF	18W	110°	227mm	CYC020SNL052N (Ripple free)	4000K	1700lm

General Specification







Voltage 220-240Vac 50-60Hz **CRI** 85
Power Factor 0.95 **Life Time** 30,000hrs
Beam Angle 80° **Ambient** -20°C to 50°C **Protection** Class II, IP20
Lumen Maintenance Factor at Nominal Lifetime 0.75

Options

Add to order code	Description	Component Code	Models
/DD	DALI Dimmable, Tridonic TALEXX driver LCA 25W 350-1050mA one4all SR PRE	KPNL-TRO25	KPNLLS18CF
/AD	1-10V dimmable, 350-1050mA	CYC050TVC35-105	KPNLLS18CF

Accessories

Type	Order Code	Description	Models
Emergency Module	CEC038LIL100N	With Li-Ion battery	All Models

-  High efficiency of up to 94lm/W, save energy by over 50% energy
-  Premium Samsung SMDs for superior CCT consistency
- UGR**  Good glare control with UGR <25
-  Plug and play emergency module for Maintained / Non-Maintained Emergency conversion
-  Dimmable Options: DALI and 1-10V
-  Long life of 40,000h

Product Code

Format:
 KPNLLS□□CF-W40-WHT
 → Rated Lamp Wattage

Code:
 KPNLLS10CF-W40-WHT
 KPNLLS12CF-W40-WHT
 KPNLLS18CF-W40-WHT

Dimensions

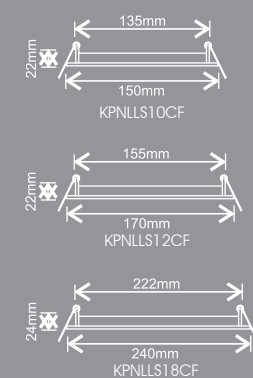

Floodlight

LED Floodlight (with PIR option)

LED floodlights are an energy efficient, robust and reliable lighting solution for a diverse range of outdoor applications. With 10W, 20W, 30W and 50W options, they offer excellent light output and instant energy savings over energy hungry halogen tungsten floodlights. This range of products also offers the option of a detachable PIR sensor.



Order Code	Power	Input Current	Power Factor	Finish	Colour	Lumen
KFLDHS10Q65	10W	81mA	0.54	Black White	3000K 6500K	730lm 750lm
KFLDHS20Q65	20W	94mA	0.93	Black	3000K 6500K	1700lm 1900lm
KFLDHS30Q65	30W	137mA	0.95	Black	3000K 6500K	2100lm 2400lm
KFLDHS50Q65	50W	229mA	0.95	Black	6500K	4500lm





Options

Add to order code	Description	Component Code	Models
/S	Supplied with detachable PIR sensor	KPT-PIR-FLD	All models

General Specification

Voltage 220-240Vac 50-60Hz **CRI** >80 **Life Time** 40,000hrs
Angle 110° **Housing** Diecast Aluminum **Protection** Class I, IP65 / IP54*
Lumen Maintenance Factor at Nominal Lifetime 0.75

*When use with PIR sensor the complete luminaire is rated IP54

-  High efficiency of up to 90lm/W, save energy by over 90% energy
-  Highly efficiency low power SMD
-  Detachable PIR sensor
-  Long life of 40,000h

Product Code

Format:
 KFLDHS□□Q65-W□□-WHT
 → Colour Temperature
 → Rated Lamp Wattage

Code:
 KFLDHS10Q65-W30-BLK KFLDHS10Q65-W30-WHT
 KFLDHS10Q65-W65-BLK KFLDHS10Q65-W65-WHT
 KFLDHS20Q65-W30-BLK KFLDHS30Q65-W30-BLK
 KFLDHS20Q65-W65-BLK KFLDHS30Q65-W65-BLK
 KFLDHS50Q65-W65-BLK

Dimensions

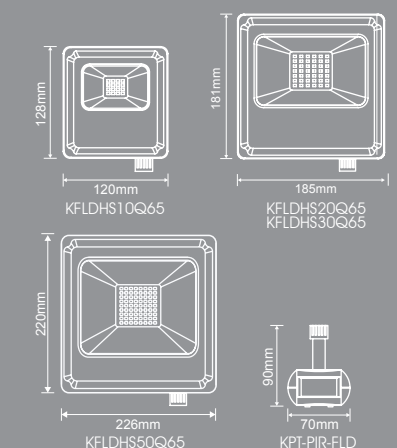

LED Floodlight

LED floodlights are an energy efficient, robust and reliable lighting solution for a diverse range of outdoor applications. With 80W and 100W options, they offer excellent light output and instant energy savings over energy hungry halogen tungsten floodlights.



80W



100W

Order Code	Power	Input Current	Power Factor	Finish	Colour	Lumen
KFLDHS80Q66	80W	355mA	0.98	Black	6500K	6400lm
KFLDHS100Q66	100W	444mA	0.98	Black	6500K	7800lm

General Specification

Voltage 220-240Vac 50-60Hz **CRI** >80 **Life Time** 40,000hrs
Angle 110° **Housing** Diecast Aluminum **Protection** Class I, IP65
Lumen Maintenance Factor at Nominal Lifetime 0.75



High efficiency of up to 80lm/W, save energy by over 90% energy



Highly efficiency low power SMD



Long life of 40,000h

Product Code

Code:
KFLDHS80Q66-W65-BLK
KFLDHS100Q66-W65-BLK

Dimensions

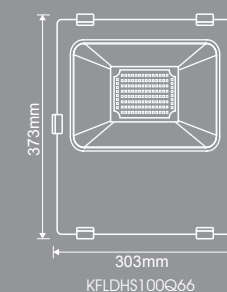
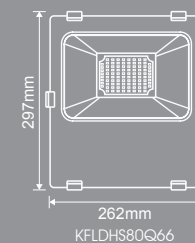

Integrated Anti-Corrosive LED Batten

Kosnic have developed a range of LED Anti-Corrosive Battens, utilising high performance LEDs to offer outstanding lumen efficiency. The Kosnic LED Anti-Corrosive battens are suitable for a wide range of commercial applications including warehouses, factories and garages. Our Anti-Corrosive Battens are extremely energy efficient with a long operational life helping to reduce energy and maintenance costs.



High efficiency of up to 94lm/W



Highly efficiency low power SMD



Protection against dust and low pressure water jet



Impact resistance rating of IK08



Long life of 40,000h

Order Code	Power	Protection	Length	Colour	Lumen
KBTN30L65	30W	Class II IP65 IK08	590mm	4000K 6500K	2700lm
KBTN50L65	50W	Class II IP65 IK08	1200mm	4000K 6500K	4800lm
KBTN70L65	70W	Class II IP65 IK08	1500mm	4000K 6500K	5700lm

General Specification

Voltage 220-240Vac 50-60Hz **CRI** >80 **Life Time** 40,000hrs
Ambient Temp -20°C to 50°C **Start Time** 0.49s **Power Factor** 0.95
Protection Class II, IP65, IK08 **Lumen Maintenance Factor at Nominal Lifetime** 0.75

Product Code

Format:
KBTN□□L65-W40
→ Rated Lamp Wattage

Code:
KBTN30L65-W40 KBTN30L65-W65
KBTN50L65-W40 KBTN50L65-W65
KBTN70L65-W40 KBTN70L65-W65

Dimensions

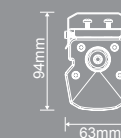
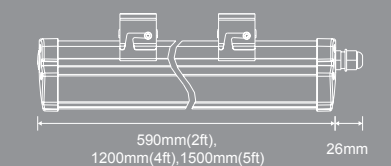







LED Anti-Corrosive Batten

The newly developed LED Anti-Corrosive Battens utilise high performance LEDs to offer outstanding lumen efficiency. They are suitable for a wide range of commercial applications including warehouses, factories and garages. This product range includes options such as microwave sensor and emergency pack.

This luminaire is compatible with Kosnic's Emergency Module.



-  High efficiency above 100lm/W
-  Highly efficiency low power SMD
-  IP65 Protection against dust and low pressure water jet
-  IK08 Impact resistance rating of IK08
-  Microwave sensor and corridors function available
-  Plug and play emergency module for Maintained / Non-Maintained Emergency conversion
-  Long life of 40,000h

Order Code	Power	Protection	Length	Colour	Lumen
KBTNHS50LS65	50W	Class II IP65 IK08	1200mm	4000K	5200lm
KBTNHS70LS65	70W	Class II IP65 IK08	1576mm	4000K	7200lm

General Specification

Voltage 220-240Vac 50-60Hz **CRI** >80 **Life Time** 40,000hrs
Ambient Temp -20°C to 50°C **Start Time** 0.49s **Power Factor** 0.95
Protection Class II, IP65, IK08 **Lumen Maintenance Factor at Nominal Lifetime** 0.75

Options

Add to order code	Description	Models
/S	With Microwave Sensor	All models
/E	With Emergency Module and NiCd Battery	All models
/S/E	With Microwave Sensor and Emergency Module and Lithium Battery	All models

Product Code

Code:
KBTNHS50LS65-W40
KBTNHS70LS65-W40

Dimensions

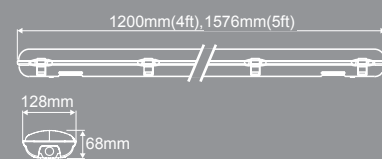

Anti-Corrosive Batten (for LED T8)

The Kosnic IP65 Battens for T8 LED Tubes are designed specifically for use with Kosnic's T8 LED Tubes. The IP65 batten fittings are suitable for a wide range of indoor and outdoor commercial applications including warehouses, factories and garages. The Kosnic T8 LED Tubes utilise high performance LEDs to offer outstanding lumen efficiency with a long operational life helping to reduce building energy and maintenance costs.



-  Fire resistant polycarbonate body and diffuser
-  IP65 Protection against dust and low pressure water jet
-  IK08 Impact resistance rating of IK08

Order Code	Max Power	Protection	Lamp	Lumen*
KBTNT8LS654F1	40W	Class II IP65 IK08	1 x 4ft LED T8	1760lm
KBTNT8LS654F2	2 x 40W	Class II IP65 IK08	2 x 4ft LED T8	3280lm
KBTNT8LS655F1	50W	Class II IP65 IK08	1 x 5ft LED T8	2200lm
KBTNT8LS655F2	2 x 50W	Class II IP65 IK08	2 x 5ft LED T8	4100lm

General Specification

Voltage 220-240Vac 50-60Hz **Lamp** LED T8 tubes
Housing Polycarbonate **Diffuser** Polycarbonate **Protection** Class II, IP65, IK08

Product Code

Code:
KBTNT8LS654F1 KBTNT8LS655F1
KBTNT8LS654F2 KBTNT8LS655F2

Dimensions

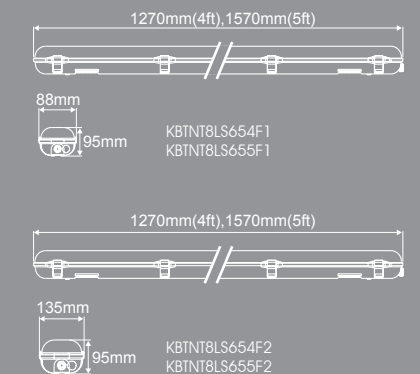

* Lumen measured when fitted with kosnic Pro LED T8 Lamps (not included)

Interior Batten (Integrated LED)

A linear surface mounted interior batten is available in 4ft, 5ft and 6ft lengths. Fitted with a polycarbonate diffuser and powder coated steel frame, they are suitable for open plan offices, classrooms, corridors or retail premises.

This luminaire is compatible with Kosnic's Emergency Module.



High Efficiency

Order Code	Power	Protection	Length	Colour	Lumen
KBTNHS20LS1	20W	Class I IP20	1255mm	4000K	2000lm
KBTNHS40LS1	40W	Class I IP20	1556mm	4000K	4000lm
KBTNHS60LS1	60W	Class I IP20	1820mm	4000K	6000lm

High Output

Order Code	Power	Protection	Length	Colour	Lumen
KBTNHS50LS1	50W	Class I IP20	1255mm	4000K	5000lm
KBTNHS70LS1	70W	Class I IP20	1556mm	4000K	7000lm
KBTNHS100LS1	100W	Class I IP20	1820mm	4000K	10000lm

General Specification

Voltage 220-240Vac 50-60Hz **CRI** >80 **Life Time** 40,000hrs
Ambient Temp -20°C to 50°C **Start Time** 0.49s **Power Factor** 0.95
Protection Class I, IP20 **Lumen Maintenance Factor at Nominal Lifetime** 0.75

Options

Add to order code	Description	Models
/S	With Microwave Sensor	KBTNHS20LS1 KBTNHS40LS1 KBTNHS60LS1
/E	With Emergency Module and NiCd Battery	All models
/S/E	With Microwave Sensor and Emergency Module and Lithium Battery	KBTNHS20LS1 KBTNHS40LS1 KBTNHS60LS1



High efficiency of up to 90lm/W



Premium Samsung SMDs for superior CCT consistency



Plug and play emergency module for Maintained / Non-Maintained Emergency conversion



Long life of 40,000h

Product Code

Code:
 KBTNHS20LS1-W40-WHT KBTNHS50LS1-W40-WHT
 KBTNHS40LS1-W40-WHT KBTNHS70LS1-W40-WHT
 KBTNHS60LS1-W40-WHT KBTNHS100LS1-W40-WHT

Dimensions

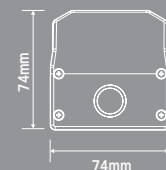
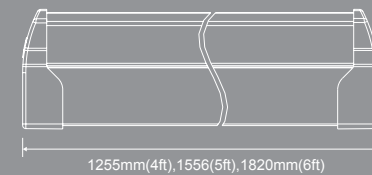

Slim-Line Interior LED Batten

The LED battens have integrated LED drivers and a slim profile for surface mounting. They offer high light output of 4960lm for the 5ft batten and 3800lm for the 4ft batten. This range of products is suitable for open plan offices, classrooms, corridors and retail premises.



High efficiency of up to 127lm/W



Highly efficient low power SMD



Long life of 40,000h

Order Code	Power	Protection	Length	Colour	Lumen
KBTNHS30LS2	30W	Class I IP20	1200mm	4000K	3800lm
KBTNHS45LS2	45W	Class I IP20	1500mm	4000K	5500lm

Product Code

Code:
 KBTNHS30LS2-W40-WHT
 KBTNHS45LS2-W40-WHT

Dimensions

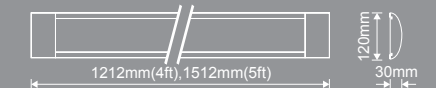

General Specification

Voltage 220-240Vac 50-60Hz **CRI** >80 **Life Time** 40,000hrs
Ambient Temp -20°C to 50°C **Start Time** 0.49s **Power Factor** 0.95
Protection Class I, IP20 **Lumen Maintenance Factor at Nominal Lifetime** 0.75

Standard Batten (for LED T8)

This range of battens is prewired for Kosnic LED T8 tubes that are supplied with the fitting. They are suitable for open plan offices, classrooms, corridors or retail premises.



Single Batten

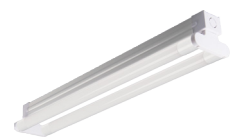

Twin Batten



Single Batten with Reflector



Twin Batten with Reflector

Order Code	Max Power	Protection	Inc. Lamps	Lamp Lumen
KBINT8LS202F1	20W	Class I IP20	1 x 8W 2ft LED T8	1000lm
KBINT8LS202F2	2 x 20W	Class I IP20	2 x 8W 2ft LED T8	2 x 1000lm
KBINT8LS204F1	40W	Class I IP20	1 x 17W 4ft LED T8	2000lm
KBINT8LS204F2	2 x 40W	Class I IP20	2 x 17W 4ft LED T8	2 x 2000lm
KBINT8LS205F1	50W	Class I IP20	1 x 25W 5ft LED T8	3000lm
KBINT8LS205F2	2 x 50W	Class I IP20	2 x 25W 5ft LED T8	2 x 3000lm

General Specification

Voltage 220-240Vac 50-60Hz **Lamp** LED T8 tubes
Housing Steel **Protection** Class I, IP20

Accessories

Type	Order Code	Description	Models
Reflector	KPT-R2F-WHT	White powder coated sheet steel reflector	KBINT8LS202F1 KBINT8LS202F2
Reflector	KPT-R4F-WHT	White powder coated sheet steel reflector	KBINT8LS204F1 KBINT8LS204F2
Reflector	KPT-R5F-WHT	White powder coated sheet steel reflector	KBINT8LS205F1 KBINT8LS205F2

Circular High Bay

The circular high bay LED modular luminaires offer energy savings, high performance and low maintenance, replacing conventional HID based luminaires in general industrial areas, such as manufacturing, warehousing, leisure facilities and retail environments. The luminaire is fitted with polished aluminum reflectors to provide good control of light with low glare.



High efficiency of up to 125lm/W



LED T8 Lamps included



Long life of 40,000h

Product Code

Code:
 KBINT8LS202F1 KBINT8LS204F1
 KBINT8LS202F2 KBINT8LS204F2

KBINT8LS205F1
 KBINT8LS205F2

Dimensions

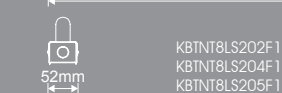

KPT-R2F-WHT
 KPT-R4F-WHT
 KPT-R5F-WHT

Order Code	Power	Input Current	Protection	Colour	Lumen
KMHD50FDCHB	50W	222mA	Class II IP20	4000K	4800lm
KMHD100FDCHB	100W	444mA	Class II IP20	4000K	9500lm

General Specification

Voltage 220-240Vac 50-60Hz **CRI** >80 **Life Time** 40,000hrs
Power Factor 0.98 **Angle** 60° **Housing** Zinc coated sheet steel
Protection Class II, IP20 **Lumen Maintenance Factor at Nominal Lifetime** 0.75



High Power of up to 9,500lm



Zinc coated mild steel and powder coating, polycarbonate diffuser



Premium Samsung SMDs for superior lumen output and color consistency



Long life of 40,000h

Product Code

Code:
 KMHD50FDCHB-W40-WHT
 KMHD100FDCHB-W40-WHT

Dimensions

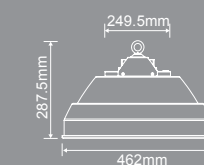





Rectangular High Bay

Rectangular High Bay LED luminaires offer energy savings, high performance and low maintenance, replacing conventional HID based luminaires in general industrial areas, manufacturing, warehousing, leisure facilities and retail environments. The luminaire is fitted with pre-anodized aluminum reflectors to provide good control of light with low glare. Mounting height of 6m-12m. Frosted diffuser available.



PIR Sensor

-  High Power of up to 22,600lm
-  Zinc coated mild steel and powder coating
-  Premium Samsung SMDs for superior lumen output and color consistency
-  Detachable PIR sensor
-  Long life of 40,000h

Order Code	Power	Input Current	Beam Angle	Protection	Colour	Lumen
KMSD150LHBE	150W	686mA	106° (Axial) 56° (Transverse)	Class I IP20	6500K	15000lm
KMSD200LHBE	200W	915mA	106° (Axial) 56° (Transverse)	Class I IP20	6500K	22600lm

General Specification

Voltage 220-240Vac 50-60Hz **CRI** >80 **Life Time** 40,000hrs
Power Factor 0.95 **Housing** Zinc coated sheet steel **Diffuser** Clear polycarbonate
Protection Class I, IP20 **Lumen Maintenance Factor at Nominal Lifetime** 0.75

Accessories





Type	Order Code	Description	Models
Sensor	EBDHS-MB-PRM-LT30	On/off output Provided by CP Electronics	All Models
Sensor	EBMPIR-MB-AD-LT30	1-10V output Provided by CP Electronics	All Models

Rectangular Low Bay

Rectangular Low Bay LED luminaires offer energy savings, high performance and low maintenance, replacing conventional HID based luminaires in general industrial areas, such as manufacturing, warehousing, leisure facilities and retail environments. The luminaire is fitted with pre-anodized aluminum reflectors to provide good control of light with low glare. Mounting height of 4.5m -7.5m. Frosted diffuser available.



PIR Sensor

-  High Power of up to 15,000lm
-  Zinc coated mild steel and powder coating
-  Premium Samsung SMDs for superior lumen output and color consistency
-  Detachable PIR sensor
-  Long life of 40,000h



Order Code	Power	Input Current	Beam Angle	Protection	Colour	Lumen
KMSD100LLBF	100W	448mA	107° (Axial) 71° (Transverse)	Class I IP20	6500K	11100lm
KMSD150LLBE	150W	686mA	107° (Axial) 71° (Transverse)	Class I IP20	6500K	15000lm

General Specification

Voltage 220-240Vac 50-60Hz **CRI** >80 **Life Time** 40,000hrs
Power Factor 0.95 **Housing** Zinc coated sheet steel **Diffuser** Clear polycarbonate
Protection Class I, IP20 **Lumen Maintenance Factor at Nominal Lifetime** 0.75

Accessories

Type	Order Code	Description	Models
Sensor	EBDHS-MB-PRM-LT30	On/off output Provided by CP Electronics	All Models
Sensor	EBMPIR-MB-AD-LT30	1-10V output Provided by CP Electronics	All Models

Product Code

Code:
 KMSD150LHBE-W65-WHT
 KMSD200LHBE-W65-WHT

Dimensions

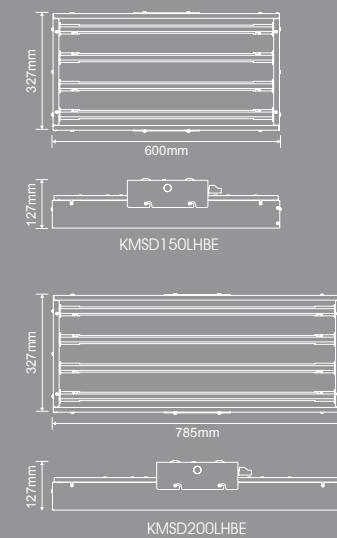

Product Code

Code:
 KMSD100LLBF-W65-WHT
 KMSD150LLBE-W65-WHT

Dimensions

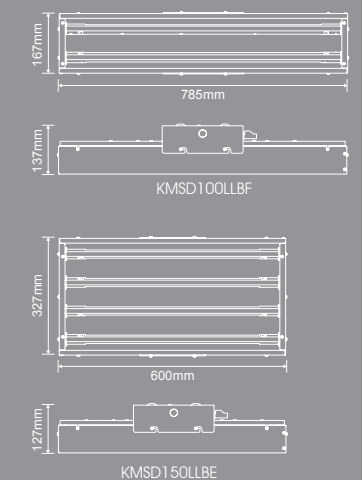

Tilt Twin Panel Low Bay

This LED Low Bay luminaire consists of 2 tilting edge-lit panels, offering higher lumen output for demanding commercial and industrial application. Each panel can be adjusted at an angle, make it ideal for warehouses or supermarkets that have low ceilings.



High efficiency of 96lm/W



Fire resistant polycarbonate diffuser (TPa)



Premium Samsung SMDs for superior CCT consistency



Long life of 40,000h

Order Code	Power	Input Current	Finish	Driver	Colour	Lumen
KPNLLS120T2S	120W	527mA	White	2*CYC060TNL150	4000K	11500lm

General Specification

Voltage 220-240Vac 50-60Hz

Power Factor >0.95

Housing Powder Coated Aluminum

CRI 4000K Ra >82

Retrofit Yes

Diffuser Polycarbonate

Life Time 40,000hrs

Ambient Temp -20°C to 50°C

Protection Class I, IP20

Product Code

Code:
KPNLLS120T2S-W40-WHT

Dimensions

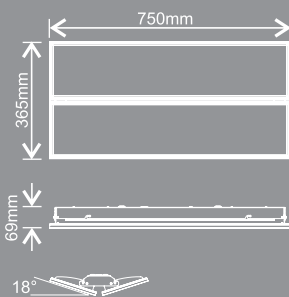

Circular Wall Washer

The Kosnic LED Adjustable Downlight rotates through 350 degrees and has a 60 degree tilt. With a 15 degree and 40 degree beam the Downlight is available in 15W, 24w or 34w versions with different colour temperatures of 2,700K to replicate halogen lighting, and cooler 5,000K. With a high CRI the Downlight has many applications such as Retail Display, Dining & Showrooms. Manufactured from Cast Aluminium with a High Quality Specula Reflector the Kosnic Adjustable Downlight delivers a lot of light to highlight many applications.



High efficiency of up to 91lm/W, save up to 90% energy



CREE Chip on Board (COB)



High CRI over 80Ra



Long life of 40,000h



15W



24W



34W

Order Code	Power	Beam Angle	Cut-out	Driver	Colour	Lumen
KWDDL15	15W	16°	90mm	CYC015SNL035N (Ripple free)	3000K 5000K	1250lm
KWDDL15	15W	36°	90mm	CYC015SNL035N (Ripple free)	3000K 5000K	1250lm
KWDDL24	24W	15°	145mm	CYC024SNL055N (Ripple free)	3000K 5000K	2000lm
KWDDL24	24W	38°	145mm	CYC024SNL055N (Ripple free)	3000K 5000K	2000lm
KWDDL34	34W	15°	170mm	CYC036SNL080N (Ripple free)	3000K 5000K	2800lm 3100lm
KWDDL34	34W	40°	170mm	CYC036SNL080N (Ripple free)	3000K 5000K	2300lm 2900lm

General Specification

Voltage 220-240Vac 50-60Hz

Power Factor >0.95

Protection Class II, IP20

CRI >80

Ambient Temp -20°C to 50°C

Life Time 40,000hrs

Housing Diecast Aluminum

Product Code

Code:
KWDDL15-B30 KWDDL15-S30
KWDDL15-B50 KWDDL15-S50

KWDDL24-B30 KWDDL24-S30
KWDDL24-B50 KWDDL24-S50

KWDDL34-B30 KWDDL34-S30
KWDDL34-B50 KWDDL34-S50

Dimensions

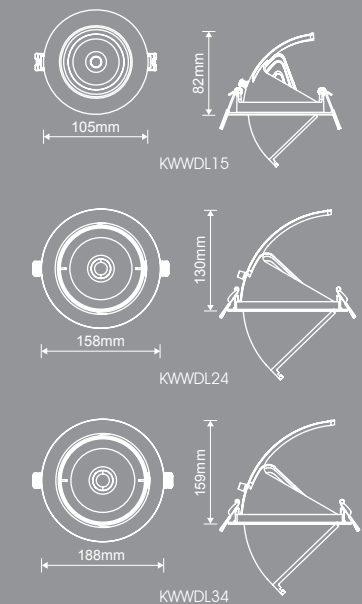

Rectangular Wall Washer

The Rectangular shaped LED Adjustable Downlight pivots through 45° and produces a wide beam of 110°. The Downlights are available in 25w or 35w with different colour temperatures of 3000K, 4000K, and 6000K. With a high CRI the Downlight has many applications such as retail displays, restaurants and showrooms.



High efficiency of up to 89lm/W, save up to 90% energy



CREE Chip on Board (COB)



High CRI over 80Ra



Long life of 40,000h

Order Code	Power	Beam Angle	Cut-out	Driver	Colour	Lumen
KWWDL25Q	25W	110°	220-130mm	CYC025SNL070N	3000K	2050lm
					4000K	2120lm
					6000K	2150lm
KWWDL35Q	35W	110°	220-130mm	CYC035SNL070N	3000K	2960lm
					4000K	3050lm
					6000K	3120lm

General Specification

Voltage 220-240Vac 50-60Hz

CRI >80

Life Time 40,000hrs

Power Factor >0.95

Ambient Temp -20°C to 50°C

Housing Diecast Aluminum

Protection Class II, IP20

Product Code

Code:

KWWDL25Q-W30 KWWDL35Q-W30
KWWDL25Q-W40 KWWDL35Q-W40
KWWDL25Q-W65 KWWDL35Q-W65

Dimensions

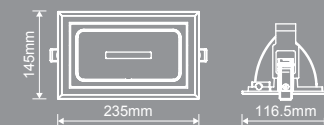

Tracklight

The Kosnic LED Tracklight is suitable for use with the GLOBAL Trac 3 Circuit Track System. The Kosnic LED Tracklight is available in 6 versions, 24W / 15 or 38 degree – 34W / 15 or 40 degree – 50W / 20 or 40 degree. With a 350 degree rotation and 180 degree tilt, the Kosnic LED Tracklight is able to deliver a lot of light right where you need it. The LED Tracklight is particularly suitable for retail display, showrooms, galleries, and museums.



Order Code	Power	Beam Angle	Colour	Lumen
KTDL24GL	24W	15°	3000K 5000K	2000lm
KTDL24GL	24W	38°	3000K 5000K	2000lm
KTDL34GL	34W	15°	3000K 5000K	2800lm 3100lm
KTDL34GL	34W	40°	3000K 5000K	2800lm 3100lm
KTDL50GL	50W	20°	3000K 5000K	4100lm
KTDL50GL	50W	40°	3000K 5000K	4100lm

General Specification

Voltage 220-240Vac 50-60Hz

CRI >80

Life Time 40,000hrs

Power Factor >0.95

Ambient Temp -20°C to 50°C

Housing Diecast Aluminum

Protection Class I, IP20



High efficiency of 91lm/W, save up to 90% energy



CREE Chip on Board (COB)



High CRI over 80Ra



Long life of 40,000h

Product Code

Code:

KTDL24GL-B30 KTDL24GL-S30
KTDL24GL-B50 KTDL24GL-S50

KTDL34GL-B30 KTDL34GL-S30
KTDL34GL-B50 KTDL34GL-S50

KTDL50GL-B30 KTDL50GL-S30
KTDL50GL-B50 KTDL50GL-S50

Dimensions

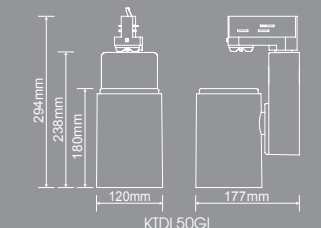
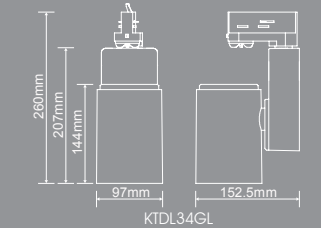
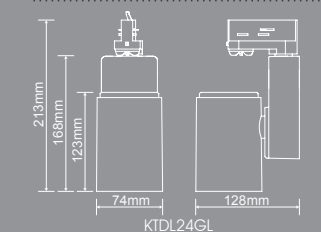

GLOBAL Trac

Please refer to Page 95 - 99 for order information of GLOBAL Trac and accessories

Spotlight Modular System

The Kosnic Retail Downlight range offers energy efficient LED lighting with a wide variety of housing options to provide different lighting effects in a wide variety of situations. Simply choose the LED module based on the output, beam angle and colour temperature, then choose a housing option from the choices of fixed and adjustable downlighters, wall washers and twin grid spotlights. The LED module and housing clip together and are easy to fit in shops, hotels, galleries, showrooms and similar premises where a high quality, high efficiency lighting solution is required.



Order Code	Power	Beam Angle	Driver	Colour	Lumen
KRDL605M15	15W	16° 36°	CYC015SNL035N (Ripple free)	5000K	1250lm



KRDL615HW
Cut-out 90mm

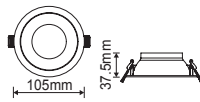

KRDL635HW
Cut-out 100mm

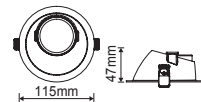

KRDL615-BHS
Cut-out 90mm

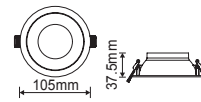

KRDL642HW
Cut-out 90mm

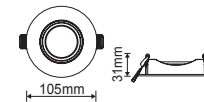

High efficiency of 91lm/W,
save up to 90% energy



CREE Chip on Board (COB)



High CRI over 80Ra



Long life of 40,000h

Product Code

Code:
KRDL605M15-B50
KRDL605M15-S50

Dimensions

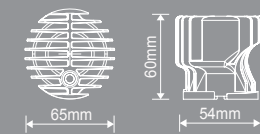

Order Code	Power	Beam Angle	Driver	Colour	Lumen
KRDL606M24	24W	15° 38°	CYC026SNL058N (Ripple free)	5000K	2000lm



KRDL606HW
Cut-out 100mm

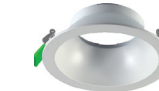
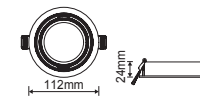

KRDL616HW
Cut-out 115mm

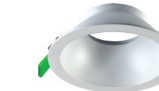
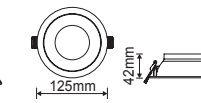

KRDL626HW
Cut-out 125mm

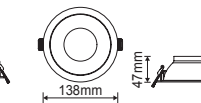

KRDL636HW
Cut-out 125mm

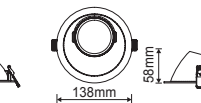

KRDL616-BHS
Cut-out 115mm

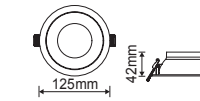

KRDL626-BHS
Cut-out 125mm

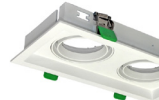
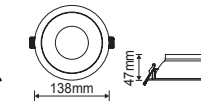

KRDL646-2HW
Cut-out 255*125mm

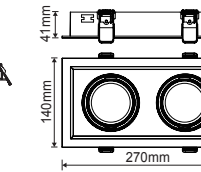

Order Code	Power	Beam Angle	Driver	Colour	Lumen
KRDL607M34	34W	15° 40°	CYC036SNL080N (Ripple free)	5000K	3100lm 2800lm



KRDL607-1HW
Cut-out 150mm

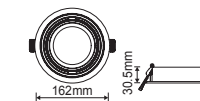

KRDL607-2HW
Cut-out 150mm

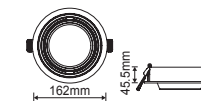

KRDL617HW
Cut-out 150mm

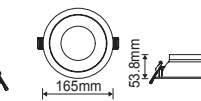

KRDL627HW
Cut-out 170mm

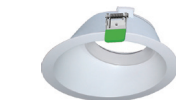
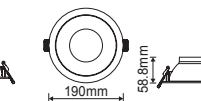

KRDL637HW
Cut-out 170mm

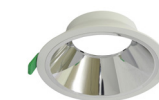
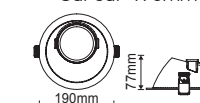

KRDL617-BHS
Cut-out 150mm

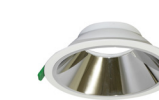
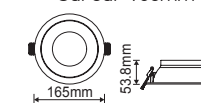

KRDL627-BHS
Cut-out 170mm

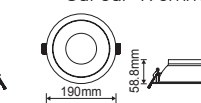

KRDL647-2HW
Cut-out 315*160mm

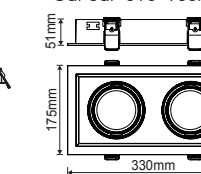

Product Code

Code:
KRDL606M24-B50
KRDL606M24-S50

Dimensions

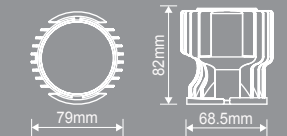

Product Code

Code:
KRDL607M34-B50
KRDL607M34-S50

Dimensions

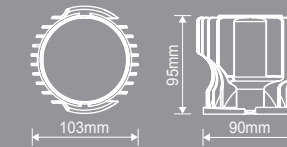



Order Code	Power	Beam Angle	Driver	Colour	Lumen
KRDL608M50	50W	20° 40°	CYC055SNL120	5000K	4100lm



General Specification

Voltage 220-240Vac 50-60Hz **CRI** >80 **Life Time** 40,000hrs
Power Factor >0.95 **Ambient Temp** -20°C to 50°C **Housing** Diecast Aluminum
Protection Class II, IP20

Product Code

Code:
 KRDL608M50-B50
 KRDL608M50-S50

Dimensions

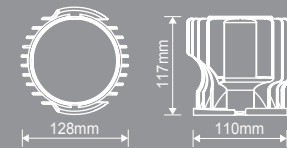

Cordless Portable Work Light

The cordless rechargeable LED Work Light has been designed and developed primarily for use on outdoor work sites but is equally useful inside the home when a temporary light source is required. The 10W and 30W models both include a high capacity lithium-ion battery allowing the light to work continuously for 3 hours (10W model) and 2 hours (30W model). The 10W work light also has a magnetic back for easy setup. A metal stand is available for the 30W work light.



Order Code	Power	Battery	Battery Capacity	Beam Angle	Colour	Lumen
KPWLLS10Q165	10W	Li-Ion	4400mAh	120°	6000K	1100lm
KPWLLS30Q165	30W	Li-Ion	8800mAh	105°	5000K	2300lm

Time for Continuous Usage

Product Code	Max Wattage	Full Light Output	50% Light Output
KPWLLS10Q165	10W	3.5 hours	10 hours
KPWLLS30Q165	30W	2.5 hours	4.5 hours

- High efficiency of 110lm/W
- CREE Chip on Board (COB)
- CRI** High CRI over 80Ra
- Long life of 40,000h

Product Code

Code:
 KPWLLS10Q165-W60
 KPWLLS30Q165-W50

Dimensions

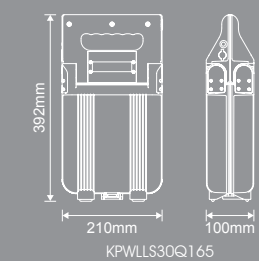
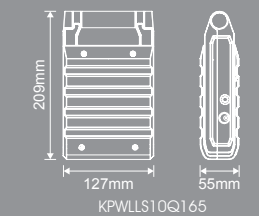



COMP

Module
P71-P72

Driver
P73-P77

Emergency Module
P78-P79

Customer: SAGA Headquarters
 Project: LED replacement of Metal Halide lamps
 Location: Telesales office
 Product: Kosnic LED Bespoke Luminaires



LED

LUMI

COMP

CFL

HALO

Module

Linear Module (DC)

The CYANARIS LED linear modules are highly efficient with excellent light quality and colour consistency for use in a wide range of architectural, general lighting and linear fixtures. The modules require supply from constant current LED control gear and are designed for easy product integration.



Order Code	Voltage	Power	Current	CRI	Colour	Lumen
CYBC450L56	30Vdc	13.5W	450mA	84 88	4000K 6500K	1600lm
CYBC750L56	30Vdc	22.5W	750mA	84 88	4000K 6500K	2300lm
CYBC1350L360X130	30Vdc	40W	1350mA	83	4000K	4700lm
CYBC330H560X40	110Vdc	36W	330mA	84	6500K	3980lm
CYBC450H745X40	120Vdc	54W	500mA	84	6500K	5980lm

Control Gear Selection

Board Code	Driver	Qty of Parallel LED Modules	Output Current	Output Voltage
CYBC450L56	CYC040TNC090	2	900mA	25-44Vdc
	CYC060TNC135	3	1350mA	25-43Vdc
	CYC060TNC175	4	1750mA	20-34Vdc
CYBC750L56	CYC060TNC135	2	1350mA	25-43Vdc
CYBC1350L360X130	CYC060TNC135	1	1350mA	25-43Vdc
CYBC330H560X40	CYC076SNC058	2	580mA	80-132Vdc
CYBC450H745X40	CYC118SNC090	2	900mA	80-132Vdc

General Specification

SDCM of CCT <6 Life Time 50,000hrs Energy Class A+
 Beam Angle 120° Ambient Temp -20°C to 50°C Max. Case Temperature tc 85°C
 Lumen Maintenance Factor at Nominal Lifetime 0.75

Product Code

Code:
 CYBC450L56/840 CYBC750L56/840
 CYBC450L56/865 CYBC750L56/865

 CYBC1350L360X130/840

 CYBC330H560X40/865

 CYBC450H745X40/865

Dimensions

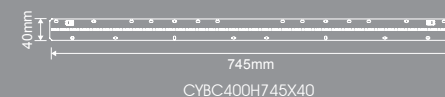
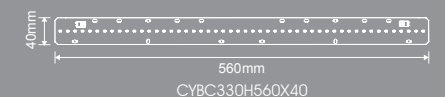
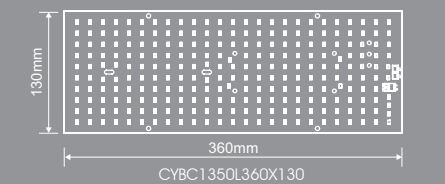
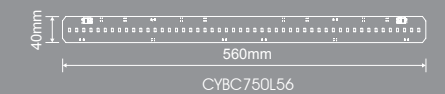
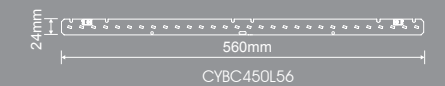

Linear Module (Mains)

The CYANARIS LED linear modules are highly efficient with excellent light quality and colour consistency for use in a wide range of architectural, general lighting and linear fixtures. The modules are operated directly from the mains supply (230V 50/60Hz) and are designed for easy product integration.

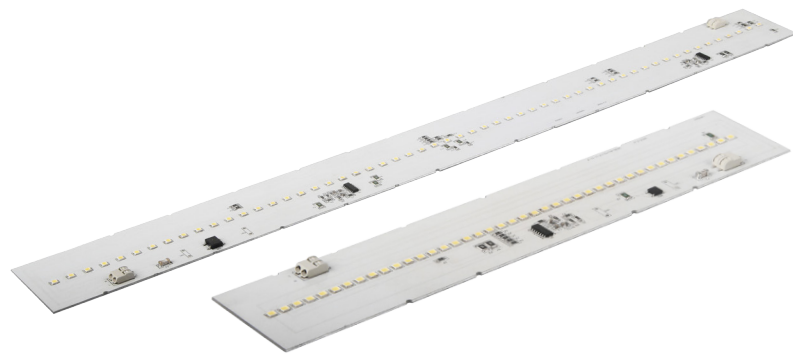

Order Code	Voltage	Power	Current	CRI	Colour	Lumen
CDBC65H280X50	230Vdc 50-60Hz	15W	65mA	87	6500K	1240lm
CDBC135H560X50	230Vdc 50-60Hz	30W	135mA	86	6500K	2580lm

General Specification

SDCM of CCT <6 Life Time 50,000hrs Energy Class A+
 Beam Angle 120° Ambient Temp -20°C to 50°C Max. Case Temperature tc 85°C
 Lumen Maintenance Factor at Nominal Lifetime 0.75

Product Code

Code:
 CDBC65H280X50/865
 CDBC135H560X50/865

Dimensions

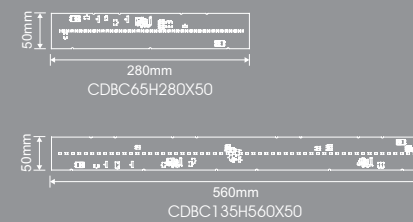

Constant Current driver (for Class II luminaires)

The CYANARIS range of constant current LED drivers support the operation of Kosnic luminaires and various professional lighting fixtures. This range of two-stage drivers offer low ripple current outputs with high power factor in a class II construction for independent installation. All drivers have built-in overload, thermal, short circuit and open circuit protection.



Order Code	Max Power	Output Current	Output Voltage	PF Correction	Power Factor	Ripple Current
CYC040TNC090	40W	900mA	25-44Vdc	Two Stage	≥0.98	≤10%
CYC040TVC090	40W	900mA	25-44Vdc	Two Stage	≥0.98	≤10% 1-10V Dimmable
CYC060TNC135	60W	1350mA	25-43Vdc	Two Stage	≥0.98	≤10%
CYC060TVC135	60W	1350mA	25-43Vdc	Two Stage	≥0.98	≤10% 1-10V Dimmable
CYC060TNC175	60W	1750mA	20-34Vdc	Two Stage	≥0.98	≤10%

General Specification

Input Voltage 180-264Vac Input Frequency 50-60Hz Protection Class II, IP20
 Start Time* 0.5s Turn Off Time* 0.5s Hold On Time 20ms
 Ambient Temp* -20°C to 50°C Max. Case Temperature tc 75°C

Product Code

Code:
 CYC040TNC090 CYC060TNC135
 CYC040TVC090 CYC060TVC135
 CYC060TNC175

Dimensions

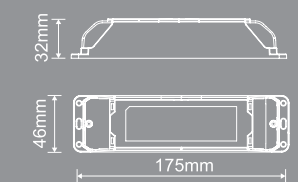

* At 230V, 50Hz, full load

Constant Current driver (for Class II luminaires)

The CYANARIS range of constant current LED drivers support the operation of Kosnic luminaires and various professional lighting fixtures. This range of single-stage drivers offer high power factor in a class II construction for independent installation and are wired ready for use. All drivers have built-in overload, thermal, short circuit and open circuit protection.



Order Code	Max Power	Output Current	Output Voltage	PF Correction	Power Factor	Ripple Current
CYC024SNL055N	24W	550mA	33-45Vdc	Single Stage	≥0.96	<10%
CYC026SNL058N	26W	580mA	26-46Vdc	Single Stage	≥0.96	<10%
CYC036SNL080N	36W	800mA	30-46Vdc	Single Stage	≥0.96	<10%
CYC036SNL091	36W	910mA	24-40Vdc	Single Stage	≥0.95	44%
CYC055SNL120	55W	1200mA	30-46Vdc	Single Stage	≥0.96	44%
CYC062SNL135	62W	1350mA	26-46Vdc	Single Stage	≥0.95	44%

General Specification

Input Voltage 180-264Vac
Start Time* 0.5s
Ambient Temp* -20°C to 50°C
Input Frequency 50-60Hz
Turn Off Time* 0.5s
Max. Case Temperature tc 75°C
Protection Class II, IP20
Hold On Time 20ms

* At 230V, 50Hz, full load

Constant Current driver (for Class II luminaires)

The CYANARIS range of constant current LED drivers support the operation of Kosnic luminaires and various professional lighting fixtures. This range of single-stage drivers offer high power factor in a class II construction for independent installation and are wired ready for use. All drivers have built-in overload, thermal, short circuit and open circuit protection.



Order Code	Max Power	Output Current	Output Voltage	PF Correction	Power Factor	Ripple Current
CYC008STL018N	8W	180mA	30-42Vdc	Single Stage	≥0.96	<10%
CYC008SNL018N	8W	180mA	30-42Vdc	Single Stage	≥0.96	<10%
CYC010SNL023N	10W	230mA	28-44Vdc	Single Stage	≥0.96	<10%
CYC012SNL031N	12W	310mA	24-40Vdc	Single Stage	≥0.96	<10%
CYC015SNL035N	15W	350mA	30-42Vdc	Single Stage	≥0.96	<10%
CYC016SNL037N	16W	370mA	28-44Vdc	Single Stage	≥0.96	<10%
CYC020SNL052N	20W	520mA	22-38Vdc	Single Stage	≥0.96	<10%

General Specification

Input Voltage 180-264Vac
Start Time* 0.5s
Ambient Temp* -20°C to 50°C
Input Frequency 50-60Hz
Turn Off Time* 0.5s
Max. Case Temperature tc 75°C
Protection Class II, IP20
Hold On Time 20ms

* At 230V, 50Hz, full load

Product Code

Code:
 CYC024SNL055N
 CYC026SNL058N
 CYC036SNL080N
 CYC036SNL091
 CYC055SNL120
 CYC062SNL135

Dimensions

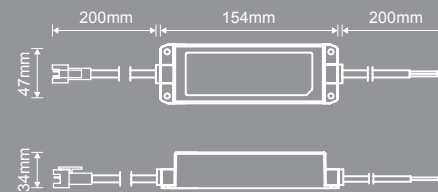

Product Code

Code:
 CYC008STL018N
 CYC008SNL018N
 CYC010SNL023N
 CYC012SNL031N
 CYC015SNL035N
 CYC016SNL037N
 CYC020SNL052N

Dimensions

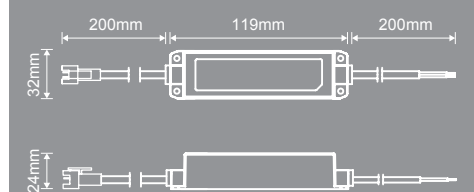

Constant Current Driver (for Class I luminaires)

The CYANARIS range of constant current LED drivers support the operation of Kosnic luminaires and various professional lighting fixtures. This range of single-stage drivers offer high power factor and are constructed for building into class I luminaires. All drivers have built-in overload, thermal, short circuit and open circuit protection.



Product Code

Code:
CYC055SNC042
CYC076SNC058
CYC118SNC090

Dimensions

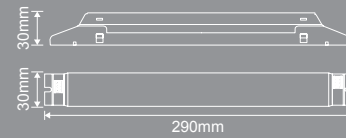

Order Code	Max Power	Output Current	Output Voltage	PF Correction	Power Factor	Ripple Current
CYC055SNC042	55W	420mA	80-132Vdc	Single Stage	≥0.95	35%
CYC076SNC058	76W	580mA	80-132Vdc	Single Stage	≥0.95	35%
CYC118SNC090	118W	900mA	80-132Vdc	Single Stage	≥0.95	35%

General Specification

Input Voltage 180-264Vac **Input Frequency** 50-60Hz **Protection** IP20
Start Time* 0.5s **Turn Off Time*** 0.5s **Hold On Time** 20ms
Ambient Temp* -20°C to 50°C **Max. Case Temperature** tc 75°C

* At 230V, 50Hz, full load

Constant Current Multifunction Dimmable LED Driver

This is a multifunctional constant current driver that has 1-10V dimming and push dimming functions. The output current of this driver can be selected by a DIP switch. It has built-in overload, short circuit and overheating protections.



Product Code

Code:
CYC050TVC35-105

Dimensions

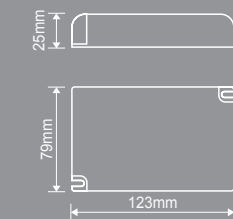

Order Code	Max Power	Output Current	Output Voltage	PF Correction	Power Factor	Ripple Current
CYC050TVC35-105	50W	350-1050mA	16-60Vdc	Two Stage	>0.9	<10%

General Specification

Input Voltage 220-240Vac **Input Frequency** 50-60Hz **Protection** Class II, IP20
Start Time* 0.5s **Turn Off Time*** 0.5s **Hold On Time** 20ms
Ambient Temp* -20°C to 50°C **Max. Case Temperature** tc 85°C

* At 230V, 50Hz, full load

Internal Plug-in Emergency Module (for LED DD lamps)

The Emergency Module, complete with internal battery, can be used to provide back-up power supply to Kosnic LED DD lamps for maintained or non-maintained emergency lighting. Easy to install inside luminaires, the modules are approved to EN61347 and supply the LED DD lamps for up to 3 hours in the event of a cut in power.



Product Code

Code:
KTC27EME-DD
CEC019LBL050S

Dimensions

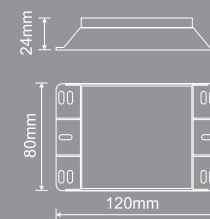

Order Code	Output Current	Output Voltage	Battery	Battery Capacity	Battery Discharge Current (Max)	Type
KTC27EME-DD	50mA	20-38Vdc	Samsung Li-Ion KBAT2200	2200mAh	270mA	Manual
CEC019LBL050S	50mA	20-38Vdc	Samsung Li-Ion KBAT2200	2200mAh	270mA	Self test

General Specification

Input Voltage 220-240Vac 50-60Hz
Emergency Conversion Time 1s
Protection Class II, IP20
Charging Time 12h
Ambient Temp -10°C to 45°C

Input Current (max) 35mA
Emergency Operation Time >3h
Battery Voltage 7.4V
Battery Life 4 Years
Maximum Case Temp 75°C

External Plug-in Emergency Module

The Emergency Module with internal battery can be used to provide back-up power supply to Kosnic luminaires for maintained or non-maintained emergency lighting. Easy to install, the modules are approved to EN61347 and supply power for up to 3 hours in the event of a cut in power.



Product Code

Code:
CEC019LIL050N
CEC038LIL100N
CEC019LIL050S
CEC038LIL100S

Dimensions

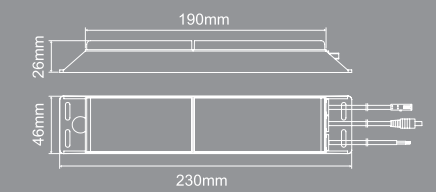

Order Code	Output Current	Output Voltage	Battery	Battery Capacity	Battery Discharge Current (Max)	Type
CEC019LIL050N	50mA	20-38Vdc	Samsung Li-Ion KBAT2200	2200mAh	270mA	Manual
CEC038LIL100N	100mA	20-38Vdc	Samsung Li-Ion KBAT2600	2600mAh	700mA	Manual
CEC019LIL050S	50mA	20-38Vdc	Samsung Li-Ion KBAT2200	2200mAh	270mA	Self test
CEC038LIL100S	100mA	20-38Vdc	Samsung Li-Ion KBAT2600	2600mAh	700mA	Self test

General Specification

Input Voltage 220-240Vac 50-60Hz
Emergency Conversion Time 1s
Protection Class II, IP20
Charging Time 12h
Ambient Temp -10°C to 45°C

Input Current (max) 35mA
Emergency Operation Time >3h
Battery Voltage 7.4V
Battery Life 4 Years
Maximum Case Temp 75°C

CFL

Spiral

P82-P83

Compact fluorescent lamps with integrated ballast

Exun

P84-P88

Plug-in Fluorescent lamps

Customer: Brunts Academy
Project: LED retrofit of existing CFLs
Location: Throughout College
Product: Kosnic LED DD bulkhead fittings
+ Emergency Modules



CFL with Integrated Ballast

This Range of CFL has integrated ballast with double turn, triple turn and spiral structured fluorescent tubes. The Spiral Lamps have a unique helix structure which allows the fluorescent tube to be twisted to an extremely compact size, giving enhanced lumen efficiency and light distribution.

Available in a wide of range of wattage from 5W to 24W, our CFLs are ideal for general lighting applications and are a long life alternative to incandescent lamps in domestic and professional settings.



Order Code	Power	Voltage	Cap	Colour	Lumen
KCF05SP3	5W	220-240V 50-60Hz	B15 B22 E14 E27	2700K	300lm
KCF07SP3	7W	220-240V 50-60Hz	B15 B22 E14 E27	2700K 4000K 6500K	350lm
KCF09SP3	9W	220-240V 50-60Hz	B15 B22 E14 E27	2700K 4000K 6500K	480lm
KCF11SP3	11W	220-240V 50-60Hz	B15 B22 E14 E27	2700K 4000K 6500K	600lm



Save up to 80% energy



High CRI over 80Ra



Long life of up to 10,000h



Minimum amalgam mercury of only 2.0mg

Product Code

Format:

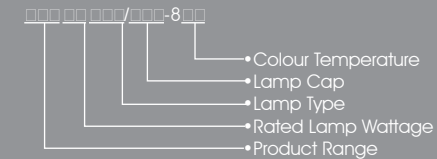

Code:

KCF05SP3/B15-827 KCF05SP3/E27-827
KCF05SP3/B22-827 KCF05SP3/E14-827

KCF07SP3/B15-827 KCF07SP3/E14-827
KCF07SP3/B22-827 KCF07SP3/E14-840
KCF07SP3/B22-840 KCF07SP3/E14-865
KCF07SP3/B22-865 KCF07SP3/E27-827
KCF07SP3/E27-840 KCF07SP3/E27-865

KCF09SP3/B15-827 KCF09SP3/E14-827
KCF09SP3/B22-827 KCF09SP3/E14-840
KCF09SP3/B22-840 KCF09SP3/E14-865
KCF09SP3/B22-865 KCF09SP3/E27-827
KCF09SP3/E27-840 KCF09SP3/E27-865

KCF11SP3/B15-827 KCF11SP3/E14-827
KCF11SP3/B22-827 KCF11SP3/E14-840
KCF11SP3/B22-840 KCF11SP3/E14-865
KCF11SP3/B22-865 KCF11SP3/E27-827
KCF11SP3/E27-840 KCF09SP3/E27-865

Dimensions

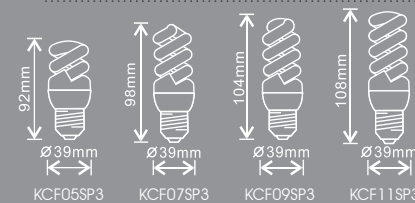

9W
Quick Start



11W
Quick Start



15W
Quick Start



18W
Quick Start



20W
Quick Start



24W
Quick Start

Order Code	Power	Voltage	Cap	Colour	Lumen
ECO09SP2	9W	220-240V 50-60Hz	B22 E27	2700K	480lm
ECO11SP2	11W	220-240V 50-60Hz	B22 E27	2700K 4000K 6500K	620lm
ECO15SP2	15W	220-240V 50-60Hz	B22 E27	2700K 4000K 6500K	825lm
ECO18SP2	18W	220-240V 50-60Hz	B22 E27	2700K 4000K 6500K	1000lm
ECO20SP2	20W	220-240V 50-60Hz	B22 E27	2700K 4000K 6500K	1100lm
ECO24SP1	24W	220-240V 50-60Hz	B22 E27	2700K 4000K 6500K	1400lm



11W
On Site



15W
On Site



20W
On Site

Order Code	Power	Voltage	Cap	Colour	Lumen
SIT11SP2	11W	110V 50-60Hz	B22 E27	2700K	640lm
SIT15SP2	15W	110V 50-60Hz	B22 E27	2700K	825lm
SIT20SP2	20W	110V 50-60Hz	B22 E27	2700K	1100lm



11W
Ecolight



20W
Ecolight

Order Code	Power	Voltage	Cap	Colour	Lumen
ECO11ST2	11W	220-240V 50-60Hz	B22 E27	2700K	630lm
ECO20ST3	20W	220-240V 50-60Hz	B22 E27	2700K	1200lm

Product Code

ECO09SP2/B22-827 ECO09SP2/E27-827

ECO11SP2/B22-827 ECO11SP2/E27-827
ECO11SP2/B22-840 ECO11SP2/E27-840
ECO11SP2/B22-865 ECO11SP2/E27-865

ECO15SP2/B22-827 ECO15SP2/E27-827
ECO15SP2/B22-840 ECO15SP2/E27-840
ECO15SP2/B22-865 ECO15SP2/E27-865

ECO18SP2/B22-827 ECO18SP2/E27-827
ECO18SP2/B22-840 ECO18SP2/E27-840
ECO18SP2/B22-865 ECO18SP2/E27-865

ECO20SP2/B22-827 ECO20SP2/E27-827
ECO20SP2/B22-840 ECO20SP2/E27-840
ECO20SP2/B22-865 ECO20SP2/E27-865

ECO24SP1/B22-827 ECO24SP1/E27-827
ECO24SP1/B22-840 ECO24SP1/E27-840
ECO24SP1/B22-865 ECO24SP1/E27-865

Dimensions

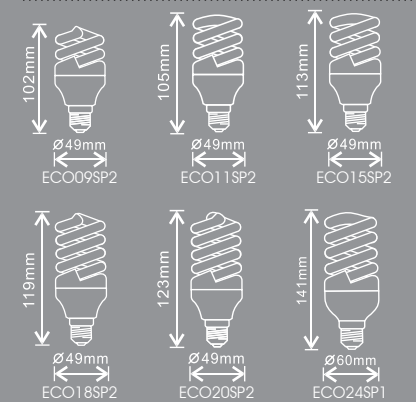

Product Code

SIT11SP2/B22-827 SIT11SP2/E27-827

SIT15SP2/B22-827 SIT15SP2/E27-827

SIT20SP2/B22-827 SIT20SP2/E27-827

Dimensions

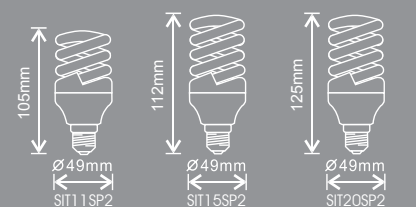

Product Code

ECO11ST2/B22-827 ECO11ST2/E27-827

ECO20ST2/B22-827 ECO20ST2/E27-827

Dimensions

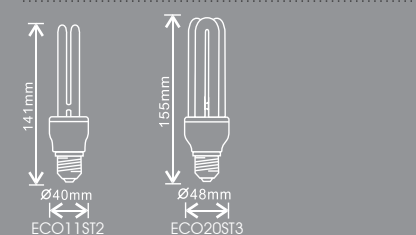



Order Code	Power	Cap	Colour	Lumen
KFT13ST3	13W	4pin(GX24q-1)	4000K	890lm
KFT18ST3	18W	4pin(GX24q-2)	4000K	1200lm
KFT26ST3	26W	4pin(GX24q-3)	4000K	1780lm
KFT32ST3	32W	4pin(GX24q-3)	4000K	2400lm
KFT42ST3	42W	4pin(GX24q-4)	4000K	3200lm

Product Code

KFT13ST3/4p-840 KFT18ST3/4p-840
KFT26ST3/4p-840 KFT32ST3/4p-840
KFT42ST3/4p-840

Dimensions

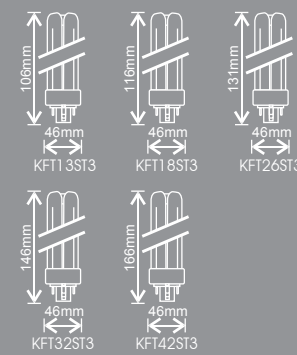

Product Code

KFT18STL/4p-840 KFT18STL/4P-840
KFT26STL/4P-840 KFT32STL/4P-840
KFT42STL/4P-840

Dimensions

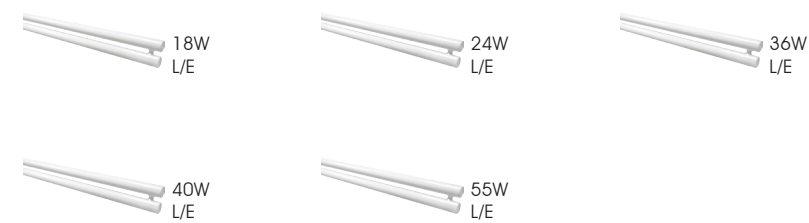
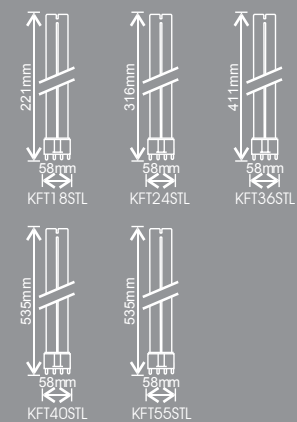

Order Code	Power	Cap	Colour	Lumen
KFT18STL	18W	4pin(2G11)	4000K	1250lm
KFT24STL	24W	4pin(2G11)	4000K	1800lm
KFT36STL	36W	4pin(2G11)	4000K	2400lm
KFT40STL	40W	4pin(2G11)	4000K	3500lm
KFT55STL	55W	4pin(2G11)	4000K	4800lm

T5, T8

A comprehensive range of linear fluorescent tubes with premium specifications. These lamps deliver a high lumen to watt ratio and are extremely robust and durable.

Designed for use in a wide variety of commercial and industrial applications such as offices, warehouses and supermarkets.



T5 High Efficiency

Order Code	Power	Cap	Length	Colour	Lumen
KFT08T5	8W	G5	228mm	4000K	450lm
KFT14T5	14W	G5	549mm	4000K	1200lm
KFT21T5	21W	G5	849mm	4000K	1850lm
KFT28T5	28W	G5	1149mm	4000K	2600lm
KFT35T5	35W	G5	1449mm	4000K	3300lm



Save up to 80% energy



High CRI over 80Ra



Long life of up to 24,000h



Minimum amalgam mercury of only 2.0mg

Product Code

Format:

KFT□□□□/8□□



Code:

KFT08T5/840
KFT14T5/840
KFT21T5/840
KFT28T5/840
KFT35T5/840

Dimensions

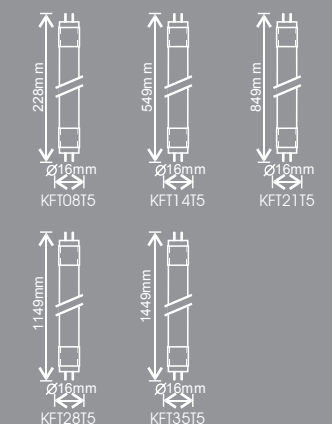



T5 High Output

Order Code	Power	Cap	Length	Colour	Lumen
KFT24T5HO	24W	G5	549mm	4000K	1750lm
KFT39T5HO	39W	G5	849mm	4000K	3300lm
KFT49T5HO	49W	G5	1149mm	4000K	4500lm
KFT54T5HO	54W	G5	1449mm	4000K	4650lm

Product Code

KFT24T5HO/840
KFT39T5HO/840
KFT49T5HO/840
KFT54T5HO/840

Dimensions

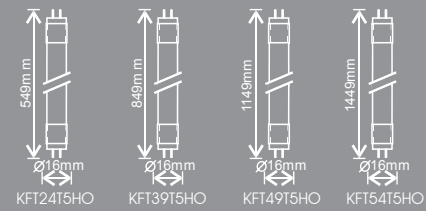

Product Code

KFT18T8/840
KFT30T8/840
KFT36T8/840
KFT58T8/840

Dimensions

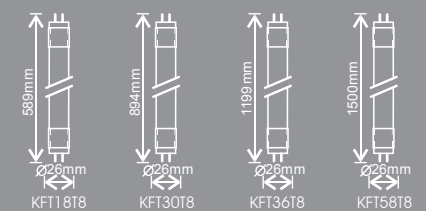

T8

Order Code	Power	Cap	Length	Colour	Lumen
KFT18T8	18W	G13	2ft/589mm	4000K	1350lm
KFT30T8	30W	G13	3ft/894mm	4000K	2250lm
KFT36T8	36W	G13	4ft/1199mm	4000K	3350lm
KFT58T8	58W	G13	5ft/1500mm	4000K	5200lm

HALO

Classic Shape

P91-P92

Reflector

P93

Capsule

P94



Customer: Cadbury World Experience
 Project: LED retrofit of PL Light Fixtures
 Location: Cadbury Shop
 Product: Kosnic 23W 8" Lumi LED downlights

LED

LUMI

COMP

CFL

HALO

Classic Shape

Candle, GLS, Golf, Reflector

Designed as a fast and direct replacement for incandescent lamps, our Classic shape halogen savers provide the same light quality as incandescent lamps and are fully dimmable with existing switches and controls.

Ideal for general illumination in the home or office, these lamps require no warm up time and are suitable for general disposal.



Save up to 30% energy



True colour reproduction, CRI of 100Ra



Operating life of 2,000h



18W
Candle



28W
Candle



42W
Candle



28W
Candle Bent-tip



42W
Candle Bent-tip

Order Code	Power	Cap	Colour	Lumen
KHL18CND	18W	B22 E14	3000K	220lm
KHL28CND	28W	B22 B15 E27 E14	3000K	370lm
KHL42CND	70W	B22 B15 E27 E14	3000K	630lm
KHL28BTP	28W	B22 B15 E27 E14	3000K	370lm
KHL42BTP	42W	B22 E27 E14	3000K	630lm

Product Code

Format:

KHL [] [] [] [] [] [] [] []

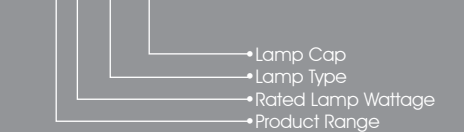

Code:

KHL18CND/B22 KHL18CND/E14

KHL28CND/B22 KHL28CND/E27
KHL28CND/B15 KHL28CND/E14

KHL42CND/B22 KHL42CND/E27
KHL42CND/B15 KHL42CND/E14

KHL28BTP/B22 KHL28BTP/E27
KHL28BTP/B15 KHL28BTP/E14

KHL42BTP/B22 KHL42BTP/E27
KHL42BTP/E14

Dimensions

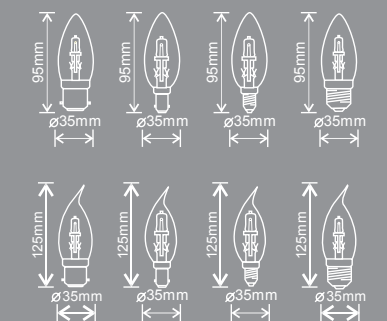

28W
GLS42W
GLS70W
GLS

Order Code	Power	Cap	Colour	Lumen
KHL28GLS	28W	B22 E27	3000K	370lm
KHL42GLS	42W	B22 E27	3000K	630lm
KHL70GLS	70W	B22 E27	3000K	1200lm

18W
Golf28W
Golf42W
Golf

Order Code	Power	Cap	Colour	Lumen
KHS18GLF	18W	B22 E27 E14	3000K	220lm
KHS28GLF	28W	B22 B15 E27 E14	3000K	370lm
KHS42GLF	42W	B22 B15 E27 E14	3000K	630lm

28W
R5042W
R6342W & 72W
R80

Order Code	Power	Cap	Colour	Lumen
KHL28R50	28W	E14	3000K	200lm
KHL42R63	42W	E27	3000K	310lm
KHL42R80	42W	E27	3000K	340lm
KHL72R80	72W	E27	3000K	610lm

Product Code

KHL28GLS/B22 KHL28GLS/E27
KHL42GLS/B22 KHL42GLS/E27
KHL70GLS/B22 KHL70GLS/E27

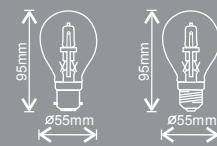
Dimensions**Product Code**

KHS18GLF/B22 KHS18GLF/E27
KHS18GLF/E14

KHS28GLF/B22 KHS28GLF/E27
KHS28GLF/B15 KHS28GLF/E14

KHS42GLF/B22 KHS42GLF/E27
KHS42GLF/B15 KHS42GLF/E14

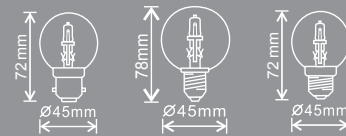
Dimensions**Product Code**

KHL28R50/E14 KHL42R63/E27
KHL42R80/E27 KHL72R80/E27

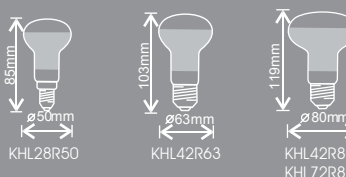
Dimensions**GU10, G5.3, MR11**

Where lighting applications demand minimal UV emissions, consider Kosnic's HALO reflector range.

These low voltage lamps give a crisp light and cool beam. For extra peace of mind, they are fully fused protected.

25W & 28W
& 42W
GU1015W & 35W
& 50W
25W & 40W
G5.320W & 35W
MR11

Order Code	Power	Cap	Colour	Lumen
KHL25MR16	25W	GU10	3000K	160lm
KHS28MR16	28W	GU10	3000K	200lm
KHS42MR16	42W	GU10	3000K	360lm
KHL15MR16	15W	G5.3	3000K	140lm
KHL35MR16	35W	G5.3	3000K	430lm
KHL50MR16	50W	G5.3	3000K	680lm
KHS25MR16	25W	G5.3	3000K	300lm
KHS40MR16	40W	G5.3	3000K	510lm
KHL20MR11	20W	GU4	3000K	200lm
KHL35MR11	35W	GU4	3000K	360lm



Save up to 30% energy

True colour reproduction,
CRI of 100RaOperating life of up to
4,000h**Product Code**

Format:

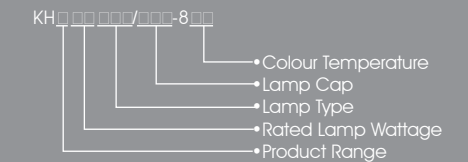

Code:

KHL25MR16/GU10-830

KHL28MR16/GU10-830

KHL42MR16/GU10-830

KHL15MR16/G5.3-DIC-830

KHL15MR16/G5.3-ALU-830

KHL35MR16/G5.3-DIC-830

KHL35MR16/G5.3-ALU-830

KHL50MR16/G5.3-DIC-830

KHL50MR16/G5.3-ALU-830

KHS25MR16/G5.3-DIC-830

KHS25MR16/G5.3-ALU-830

KHS40MR16/G5.3-DIC-830

KHS40MR16/G5.3-ALU-830

KHL20MR11/GU4-DIC

KHL35MR11/GU4-DIC

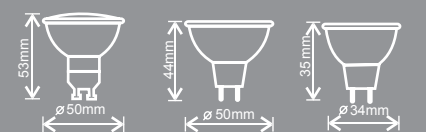
Dimensions

KHLXXMR16/GU10 KHLXXMR16/G5.3 KHLXXMR11/GU4
KHSXXMR16/GU10 KHSXXMR16/G5.3

G9, G4, GY6.35

For domestic and professional environments where true colour reproduction is essential, Kosnic offer a complete range of halogen capsules.

Our G9 halogen saver capsules help to reduce energy costs by up to 30% energy without compromising light quality.



18W & 28W
& 42W
G9



10W & 20W
G4



35W & 50W
GY6.35

Order Code	Power	Cap	Colour	Lumen
KHS18CPL	18W	G9	3000K	205lm
KHS28CPL	28W	G9	3000K	370lm
KHS42CPL	42W	G9	3000K	630lm
KHL10CPL	10W	G4	3000K	100lm
KHL20CPL	20W	G4	3000K	290lm
KHL35CPL	35W	GY6.35	3000K	600lm
KHL50CPL	50W	GY6.35	3000K	900lm



Save up to 30% energy



True colour reproduction,
CRI of 100Ra



Operating life of 2,000h

Product Code

Format:

KH□□□□□-CLE



Code:

KHS18CPL/G9-CLE
KHS28CPL/G9-CLE
KHS42CPL/G9-CLE
KHL10CPL/G4-CLE
KHL20CPL/G4-CLE
KHL35CPL/GY6.35-CLE
KHL50CPL/GY6.35-CLE

Dimensions

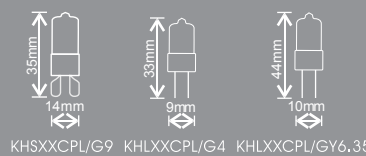

GLOBAL Trac Reference

GLOBAL Trac Pro

L1/L2/L3/neutral/ground 16 A/400 V. IP20.

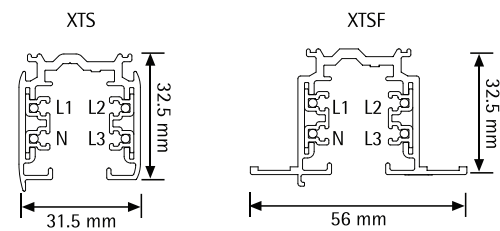
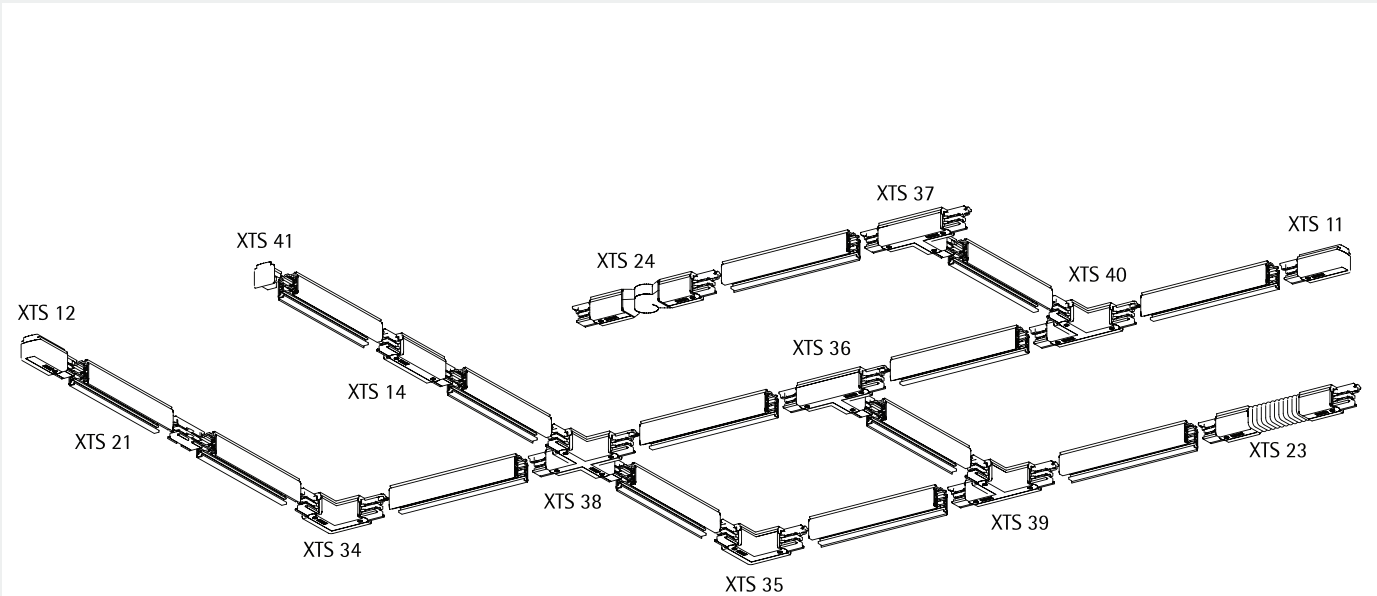

The recommended fastening distance is 1000 mm.
NOTE: A load not heavier than 10 kg may hang on a power takeoff adapter, the pull strength being 100 N (1kp = 9.81N) and the maximum torque 2.5 Nm. (GA 69 5 kg/50 N).

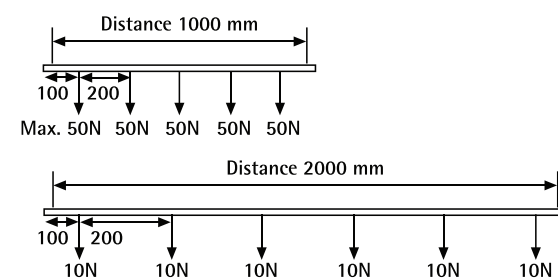

L/mm	a/mm	b/mm	c/mm	d/mm
1000	250			
2000	250	1000		
3000	250		1000	1000
4000	250		1500	1000

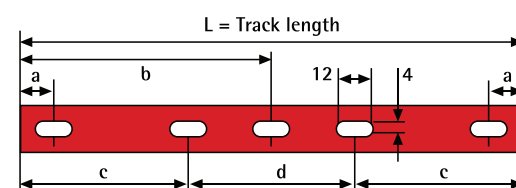

GLOBAL Trac Pro tracks

Available colours: - 1 grey (AW 202JR), -2 black (RAL 9005), -3 white (RAL 9010).

XTS
4100-4400

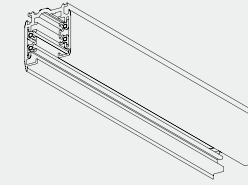

Type	EAN code	Dimensions in mm/ track length	Surface treatment/colour/ material	PCS/ Package
XTS 4100-1	64100 14 507 01-5	1000	Grey	4/240
XTS 4100-2	64100 14 506 01-8	1000	Black	4/240
XTS 4100-3	64100 14 507 06-0	1000	White	4/240
XTS 4200-1	64100 14 507 02-2	2000	Grey	4/240
XTS 4200-2	64100 14 506 02-5	2000	Black	4/240
XTS 4200-3	64100 14 507 07-7	2000	White	4/240
XTS 4300-1	64100 14 507 03-9	3000	Grey	4/240
XTS 4300-2	64100 14 506 03-2	3000	Black	4/240
XTS 4300-3	64100 14 507 08-4	3000	White	4/240
XTS 4400-1	64100 14 507 04-6	4000	Grey	4/240
XTS 4400-2	64100 14 506 04-9	4000	Black	4/240
XTS 4400-3	64100 14 507 09-1	4000	White	4/240

XTSF
4100-4400

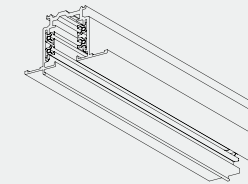

XTSF 4100-1	64100 14 507 51-0	1000	Grey	6/180
XTSF 4100-2	64100 14 506 51-3	1000	Black	6/180
XTSF 4100-3	64100 14 507 56-5	1000	White	6/180
XTSF 4200-1	64100 14 507 52-7	2000	Grey	6/180
XTSF 4200-2	64100 14 506 52-0	2000	Black	6/180
XTSF 4200-3	64100 14 507 57-2	2000	White	6/180
XTSF 4300-1	64100 14 507 53-4	3000	Grey	6/180
XTSF 4300-2	64100 14 506 53-7	3000	Black	6/180
XTSF 4300-3	64100 14 507 58-9	3000	White	6/180
XTSF 4400-1	64100 14 507 54-1	4000	Grey	6/180
XTSF 4400-2	64100 14 506 54-4	4000	Black	6/180
XTSF 4400-3	64100 14 507 59-6	4000	White	6/180

GLOBAL Trac Pro accessories

Power supply option in all connectors except XTS 21, XTS 23 and XTS 24. All materials used are halogen free and VO-self-extinguishing. Available colours: -1 grey (RAL 7040), -2 black (RAL 9005), -3 white (RAL 9010).

End feed
XTS 11

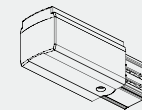

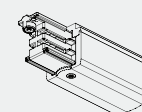

Type	EAN code	Polarity ridge	Surface treatment/colour/ material	PCS/ Package
XTS 11-1	64100 14 507 15-2		Grey	10/100
XTS 11-2	64100 14 506 11-7		Black	10/100
XTS 11-3	64100 14 507 11-4		White	10/100
XTS 12-1	64100 14 507 16-9		Grey	10/100
XTS 12-2	64100 14 506 12-4		Black	10/100
XTS 12-3	64100 14 507 12-1		White	10/100

XTS 12



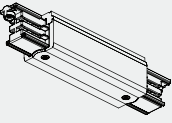
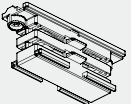
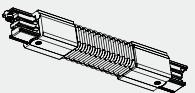
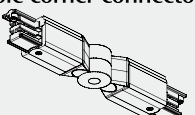
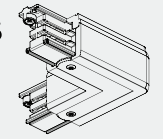
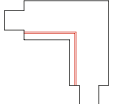
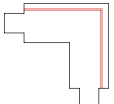
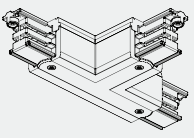
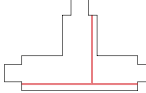
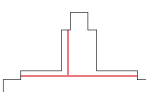
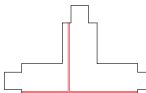

GLOBAL Trac Pro accessories

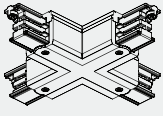
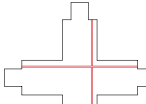
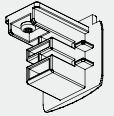
Power supply option in all connectors except XTS 21, XTS 23 and XTS 24.
Available colours: -1 grey (RAL 7040), -2 black (RAL 9005), -3 white (RAL 9010).

	Type	EAN code	Polarity ridge	Surface treatment/colour/material	PCS/Package
Middle feed XTS 14 	XTS 14-1	64100 14 507 17-6		Grey	5/50
	XTS 14-2	64100 14 506 14-8		Black	5/50
	XTS 14-3	64100 14 507 14-5		White	5/50
Straight connector XTS 21 	XTS 21-1	64100 14 507 18-3		Grey	10/100
	XTS 21-2	64100 14 506 21-6		Black	10/100
	XTS 21-3	64100 14 507 21-3		White	10/100
Flexible corner connector XTS 23 	XTS 23-1	64100 14 507 20-6		Grey	5/25
	XTS 23-2	64100 14 506 23-0		Black	5/25
	XTS 23-3	64100 14 507 23-7		White	5/25
Adjustable corner connector XTS 24 	XTS 24-1	64100 14 507 19-0		Grey	5/25
	XTS 24-2	64100 14 506 24-7		Black	5/25
	XTS 24-3	64100 14 507 24-4		White	5/25
L-feed XTS 34, 35 	XTS 34-1	64100 14 507 25-1		Grey	5/25
	XTS 34-2	64100 14 506 34-6		Black	5/25
	XTS 34-3	64100 14 507 34-3		White	5/25
	XTS 35-1	64100 14 507 26-8		Grey	5/25
	XTS 35-2	64100 14 506 35-3		Black	5/25
	XTS 35-3	64100 14 507 35-0		White	5/25
T-feed XTS 36, 37, 39, 40 	XTS 36-1	64100 14 507 27-5		Grey	5/25
	XTS 36-2	64100 14 506 36-0		Black	5/25
	XTS 36-3	64100 14 507 36-7		White	5/25
	XTS 37-1	64100 14 507 28-2		Grey	5/25
	XTS 37-2	64100 14 506 37-7		Black	5/25
	XTS 37-3	64100 14 507 37-4		White	5/25
	XTS 39-1	64100 14 507 30-5		Grey	5/25
	XTS 39-2	64100 14 506 39-1		Black	5/25
	XTS 39-3	64100 14 507 39-8		White	5/25
XTS 40-1	64100 14 507 31-2		Grey	5/25	
XTS 40-2	64100 14 506 40-7		Black	5/25	
XTS 40-3	64100 14 507 40-4		White	5/25	
X-feed XTS 38 	XTS 38-1	64100 14 507 29-9		Grey	5/25
	XTS 38-2	64100 14 506 38-4		Black	5/25
	XTS 38-3	64100 14 507 38-1		White	5/25
End cap XTS 41 	XTS 41-1	64100 14 507 32-9		Grey	10/100
	XTS 41-2	64100 14 506 41-4		Black	10/100
	XTS 41-3	64100 14 507 41-1		White	10/100

GLOBAL Trac Pro other parts

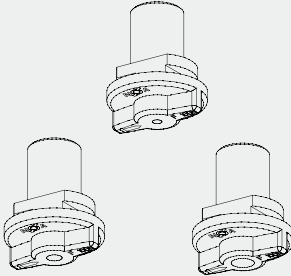
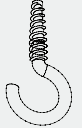
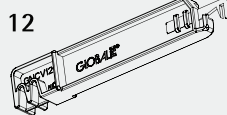
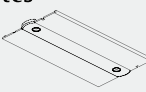
Available colours: -1 grey (RAL 7040), -2 black (RAL 9005), -3 white (RAL 9010).

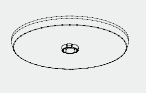
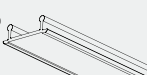
	Type	EAN code	Surface treatment/colour/material	PCS/Package
Hook base XTAK 142, 144, 146 	XTAK 142-1	64100 14 507 43-5 For 2 mm wire/hook	Grey	50/250
	XTAK 142-2	64100 14 506 42-1 For 2 mm wire/hook	Black	50/250
	XTAK 142-3	64100 14 507 42-8 For 2 mm wire/hook	White	50/250
	XTAK 144-1	64100 14 507 45-9 For M4 nut/rod	Grey	50/250
	XTAK 144-2	64100 14 506 44-5 For M4 nut/rod	Black	50/250
	XTAK 144-3	64100 14 507 44-2 For M4 nut/rod	White	50/250
	XTAK 146-1	64100 14 507 47-3 For M6 nut/rod	Grey	50/250
	XTAK 146-2	64100 14 506 46-9 For M6 nut/rod	Black	50/250
	XTAK 146-3	64100 14 507 46-6 For M6 nut/rod	White	50/250
Hook XTAK 11 	XTAK 11-1	64100 14 500 79-5 Hook 2 mm	Steel	100/5000
Tool XTSV 12 	XTSV 12	64100 14 500 99-3 Bending tool for power wires	Blue	1/100
Cover plates XTSF 10 	XTSF 10-1	64100 14 500 41-2 Cover plate for XTS11-14	Grey	1/100
	XTSF 10-2	64100 14 506 61-2 Cover plate for XTS11-14	Black	1/100
	XTSF 10-3	64100 14 507 61-9 Cover plate for XTS11-14	White	1/100
XTSF 30 	XTSF 30-1	64100 14 506 42-9 Cover plate for XTS34-40	Grey	1/100
	XTSF 30-2	64100 14 506 62-9 Cover plate for XTS34-40	Black	1/100
	XTSF 30-3	64100 14 507 62-6 Cover plate for XTS34-40	White	1/100
XTSF 40 	XTSF 40-1	64100 14 506 43-6 Outlet/cover plate for feeds	Grey	1/100
	XTSF 40-2	64100 14 506 63-6 Outlet/cover plate for feeds	Black	1/100
	XTSF 40-3	64100 14 507 63-3 Outlet/cover plate for feeds	White	1/100
Cover strip XTSP 11 	XTSP 11-2	64100 14 530 99-0 Cover strip, 3000 mm	Black	10/100
	XTSP 11-3	64100 14 530 98-3 Cover strip, 3000 mm	White	10/100

Use of L- and T-accessories

Red line indicates polarity ridge

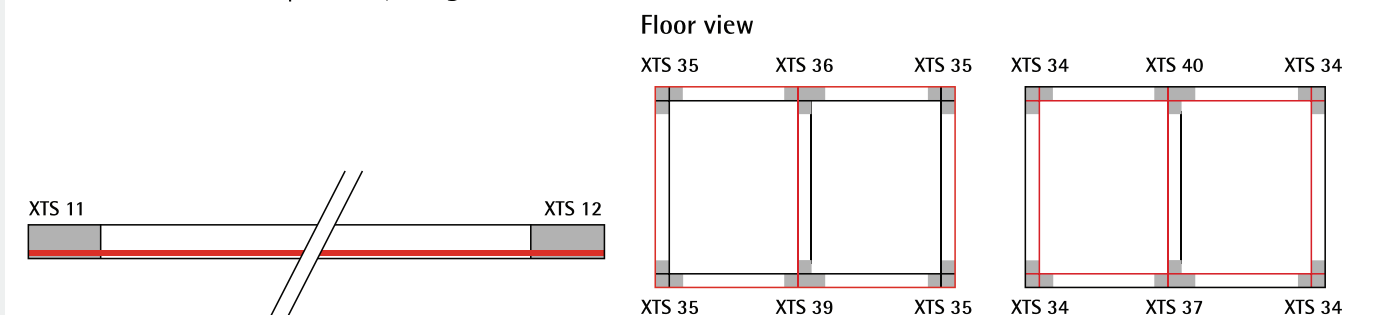

Glossary

0-10V Dimming:

Simple yet reliable electronic lighting control system used to communicate between controller and device, through the use of two low voltage wires in addition to power supply cables. A similar protocol to DALI but with a control signal of DC voltage that varies between 0-10V.

Accent Lighting:

Using a light source to directly highlight an object or part of a specified area using a beam angle less than 90°.

Ambient Temperature Range (or Operating Temperature):

The temperature of the environment where an LED light source is installed. Operating an LED light source beyond the specified operating temperature will lower the LEDs life span.

Beam Angle:

The angle at which light is distributed or emitted between two imaginary lines radiating from the face of the light source. At this point, the intensity of the light is 50% of the central intensity. Light output is not restricted to this beam.

Cap (or Lamp Base):

The part of the lamp that is used to make contact with and conduct electricity in a luminaire. Common types of domestic cap include threaded E27 and E14, bayonet B22 and B15, G9 capsule and GU10. The cap type also determines the voltage supply that can be connected and differentiates between mains voltage and lower safety voltages.

COB LED:

Chip on Board LED technology that interconnects bare LED chips to a substrate material by conductive or non-conductive adhesive. Electrical connection is achieved with wire bonding, packaged together by silica gel, epoxy resin or other materials. The COB system provides several related benefits such as greater flexibility in design, better light distribution, better colour mixing and a simpler manufacturing process.

Colour Rendering Index (CRI):

A measurement of the amount of colour shift an object undergoes when illuminated by a light source. This is compared with the colour of the same object seen under a reference light source of comparable temperature. LED light CRI values generally range from 60 (average) to 90 (best). High CRI equates to more natural colour.

Luminous Flux (lumen or lm):

The rate of light emitted by a light source, measured in lumens. Directional lamps (such as spotlights) must now state the useful luminous flux, which is the luminous flux measured within a restricted cone of 90° angle. This differs from total luminous flux, which measures total light output in all directions.

Correlated Colour Temperature (CCT):

Expressed in degrees Kelvin (K), it is the colour of a light source relative to a reference source at a particular temperature. Incandescent lighting typically has a low colour temperature of around 2800K and gives an orange tone known as Warm White. Cool White is rated at around 4000K and contains less of the yellow light. Lamps of 6000K and above tend to have more blue in the spectrum and are often referred to as Daylight.

Current:

The flow of electrical charge through a circuit, measured in Amperes. With alternating current (AC) the movement of electric charge periodically reverses direction. With direct current (DC) the flow of electric charge is only in one direction. It is important to match the voltage and current of the power supply or driver to the light source.

DALI:

DALI (Digital Addressable Lighting Interface) is a standard protocol for controlling lighting. The system transfers control signals between controller and device (such as dimmable DALI LED drivers) via two low voltage wires in addition to the power supply cables.

Dimmable:

The facility to reduce the light level of a lamp or luminaire through an external control device. With dimmable LED lamps it is important to realise that not all dimmer switches will provide effective, smooth and flicker free dimming therefore guidelines on compatibility should be consulted.

Energy Class:

The energy efficiency of the product is calculated from the wattage, useful luminous flux and some correction factors. Classes range from A++ to G according to formulas in EU directives, with A++ being the most energy efficient and G the least efficient.

Equivalent Wattage:

The wattage of an equivalent incandescent lamp. This is calculated from the useful luminous flux and beam angle once correction factors have been applied, in formulas specified by EU directives according to technology type.

Fire Rated:

Building regulations specify that divisions between certain properties and functional spaces are separated by partitions (such as fire rated ceilings) in order to slow the spread of fire. When a cut out is made for a downlight or recessed luminaire, the product itself must be suitably fire rated in order to maintain the integrity of the ceiling's fire rating.

UGR:

UGR (Unified Glare Ratio) is a method used to evaluate the direct glare from luminaires in a room when assessing the entire lighting installation at a defined observer position.

IP Rating:

An IP rating (Ingress Protection) is a two digit code given to an electrical item to indicate the degree of protection afforded by the enclosure. The first digit represents protection against penetration by solid objects accessing hazardous parts, the second describing the enclosure's protection against the ingress of water. IP44 is protection from objects over 1mm and water splashing from multiple directions, IP65 indicates protection from dust and low pressure jets of water.

LED:

LEDs (Light Emitting Diodes) are solid state devices that do not require the heating process of a filament to create light. Instead, electricity is passed through a chemical compound that once activated generates light. LEDs are not lamps in themselves, they require assembly with ancillary component parts and connection to a circuit board. This will allow electricity to pass through at a specified voltage and current while managing heat dissipation.

PIR Sensor:

PIR (Passive Infrared) sensor is an electronic device that detects the infrared radiation emitted from an object in its field of view. They are most often used in motion detectors and rely on line of sight to detect movement.

Lifetime:

This usually refers to the average operational life of a light source until failure, or at a specified lumen maintenance level. A lifetime expressed as L70B50 would be defined as the average time until 50% of the samples fail or drop to a lumen maintenance level of 70%.

Lumen Maintenance:

How well a light source retains its intensity over an extended period of time when compared to new. Typically, a high power LED lamp will retain 70% of its intensity for between 30,000 and 50,000 hours. This means a good quality LED lamp will run for 8 hours per day for 13 years at 70% of its original intensity compared to new. No other type of light source can do this.

Luminaire:

A luminaire is a light fixture or fitting used to create artificial light through use of a replaceable or non-replaceable lamp. The lamp requires a luminaire to connect to a power supply but a luminaire does not necessarily require a lamp.

SMD LED:

An SMD (Surface Mount Device) is a simple, low profile LED suitable for mounting on a PCB. The LEDs are powerful and bright with a long lifespan, but should be arranged in arrays to achieve the illumination level expected from luminaires and lamps.

Lux (or Illuminance):

The amount of luminous flux falling on a surface measured in lumens per metre², lm/m² or lux.

Maintained / Non-Maintained

Emergency Luminaire:

A maintained emergency luminaire may be energised at all times. A non-maintained emergency luminaire is only energised when the power supplied to normal lighting fails.

Microwave Sensor:

An automatic lighting control that detects when an area is occupied to switch lighting on. Microwave sensors transmit an inaudible microwave that can penetrate non-metallic objects such as glass and plastic, monitoring reflections from walls or objects in the room irrespective of heat or light. Line of sight issues do not affect microwave sensors as any solid object movement changes the pattern of the reflections and activates the sensor. This enables them to be enclosed for protection, creating sensitive devices that are activated by motion and unaffected by temperature and climate.

LED Driver:

Control gear that maintains a constant electrical supply to an LED light source. This includes circuitry to rectify the alternating current supply into direct current and convert the voltage to an appropriate value.

Power Factor:

The ratio of real power used to do work to the apparent power supplied to the circuit, which is caused by the voltage and the current being out of phase with each other. A load with a low power factor draws more current than a load with a high power factor for the same amount of useful power transferred.

Voltage:

The potential difference in electrical charge between two points in an electrical field. The greater the voltage, the greater the pressure of electrical current. As with current, the voltage can be direct or alternating. However, direct voltage maintains the same polarity while the polarity reverses direction periodically in alternating voltage. The number of complete cycles per second is the frequency. Many products run directly from the normal alternating current at mains supply voltage but some products require a lower voltage supply. In this case, an LED driver is required between the mains voltage supply and the lamp or luminaire to supply an appropriate lower voltage.

Wattage (Power/Load):

This is the rate of energy consumed by an electrical device in operation, expressed as Watts. It is related to voltage and current by the following formula: Voltage x Amps x Power Factor = Watts. The total amount of energy used to run an electrical device is calculated as wattage x hours used.

Warranty Policy

LED Lighting Product Warranty:

Kosnic Lighting Ltd warrants that all LED lighting products comply with their published specifications and are free from defects in materials and workmanship for the respective periods of time set forth below.

Kosnic LED lighting products with rated life of greater than 25,000 hours are warranted for 3 years. Other Kosnic lighting products are warranted for 1 year. An extended 5 year warranty can be offered if the 'Application for an extended 5 year warranty form' is approved. Should a Kosnic LED lamp or luminaire fail within the warranty period from the invoice date, Kosnic will provide replacement products free of charge. The acceptance of any claim under this warranty is subject to our warranty terms and conditions.

If the product is no longer available, Kosnic will provide the closest alternative product or the value of alternative product at its absolute discretion. If a close alternative product is not available, Kosnic will reimburse the warranty holder with the last price paid for the original product. The obligation to replace any product under the terms of this warranty shall only apply where it has been used for its intended or ordinary purpose and provided always that the following conditions have been met:

Kosnic LED products must be installed correctly, in accordance with the product information detailed on our packaging, instruction sheets, product data sheets and best industry practice.

Kosnic LED products under this warranty should not be operated over 5000 hours per year on average within the warranty period. If the Kosnic LED product is intended to be used for more than 5000 hours a year, a separate Warranty will be issued upon request.

Kosnic LED products are designed to operate within the following parameters:

Ambient Temperature: -20°C to +40°C

Relative Humidity: <80%

LED Lamps Fitted Into Open Luminaires:

Kosnic LED lamps are designed to be used in "open luminaires" and should have a minimum of 10mm air flow around the body of the lamp.

LED Lamps Fitted Into Enclosed Luminaires:

Kosnic LED lamps are not designed to be used in completely enclosed luminaires where air flow is prevented. The lamp life of Kosnic LED lamps in such fittings will be reduced and is unquantifiable and as such will fall outside of the terms of this warranty.

Kosnic Mains Voltage LED Products:

Kosnic mains voltage LED products are designed to operate at 230V (+/- 10%) 50-60Hz. Any fluctuation in excess of this will invalidate the terms of this warranty.

Kosnic 12V LED Products:

For all Kosnic 12V LED lamps, this warranty will only be valid if they are used with 12V DC constant voltage LED Driver. Unless stated otherwise, the use of halogen lamp transformer with kosnic 12V LED products invalidates this warranty

Kosnic LED Tubes:

The Kosnic LED tube range must be installed as directed in the installation guide. LED tubes may be used in enclosed luminaires, however they must operate in an ambient temperature between -20°C to +40°C and have a minimum of 10mm air gap around the tube.

Compatibility:

Kosnic Lighting Ltd cannot be held responsible for incompatibility of any lamp or luminaire with other manufacturers' transformers, drivers, dimmers or control gear. A guide to compatibility is published on the Kosnic web site and is available on demand. Technical advice is always available upon request.

Warranty Terms and Conditions:

1. Scope of Warranty

1.1 The warranty shall only apply to Kosnic branded lighting products sold in the UK (the 'Product') and shall apply for the benefit of a purchaser or end user (the 'User').

1.2 In these terms Kosnic refers to Kosnic Lighting Limited.

1.3 Kosnic warrants that the Product will be free from defects in material and workmanship.

1.4 The warranty set out herein shall be valid for the specified warranty period from the invoice date of purchasing the product.

1.5 If the Product fails, Kosnic will provide free replacement of the failed Product subject to the terms and conditions set out herein.

2. Terms and Conditions

2.1 If the Product as covered by this warranty is returned by a User in accordance with clause 3 below and within the applicable warranty period referred to at clause 1.4 herein and upon examination Kosnic determines to its satisfaction that such Product failed to satisfy this warranty, Kosnic will, at its sole option, repair or replace the Product or the defective part thereof, or reimburse the User for the purchase price.

2.2 The repair, replacement or otherwise of the Product shall not include any removal or reinstallation activities, costs or expenses, including without limitation, labour costs or expenses.

2.3 If Kosnic elects to replace the Product and is not able to do so because it has been discontinued or is not available, Kosnic may, at its sole option, replace the product with a comparable product or offer a reimbursement of the purchase price.

2.4 If required by Kosnic, the non-conforming or defective Product or part thereof shall become its property as soon as they have been replaced.

2.5 This warranty shall not apply where the Product has not been properly wired and installed and operated within the electrical values, operating range and environmental conditions provided in the specifications, application guidelines, IEC standards or any other document accompanying the Products. If a Product is found to be defective or not performing in accordance with the product specifications, the User must notify Kosnic in writing.

2.6 This warranty does not apply to damage or failure to perform arising as a result of any act of god or from any abuse, misuse, abnormal use or use in violation of any applicable standard, code or instructions for use including without limitation those contained in the latest safety, industry and/or electrical standards for the relevant region(s).

2.7 This warranty shall be void in the event any repairs or alterations, not duly authorised by Kosnic in writing, are made to the Product by any person. The manufacturing date of the product has to be clearly readable.

2.8 The decision of Kosnic as to the validity of any claim under this warranty shall be final.

3. Warranty Claims

3.1 The period set out at clause 1.4 herein shall be subject to a representative of Kosnic having access to the failed product or system for verification of non-compliance if required at Kosnic's sole option.

3.2 Any claim under this warranty must be reported to Kosnic within 30 days of discovery and any Product or part thereof returned promptly to Kosnic at its request.

3.3 Any claim under this warranty must be made in writing and specify details of the failed Product, purchase date, installation date, description of problem, number and percentage of failures, date-code of failures, application, hours burned and switching cycles.

3.4 If a warranty claim is accepted by Kosnic, it will pay for reasonable packaging and postage costs.

3.5 In the event that a claim is subsequently rejected, Kosnic may charge the User for the costs of investigation and reasonable packaging and postage costs.

4. No implied or other warranties

4.1 This warranty and the rights and remedies contained within it shall be the only warranties given by Kosnic in relation to the Product and are given in lieu of all other warranties, whether express or implied, including without limitation warranties of quality or fitness for a particular purpose, which warranties are hereby disclaimed.

4.2 This warranty sets out the entire liability and obligation of Kosnic to the User and the User acknowledges that it or their sole and exclusive remedy in connection with defective or nonconforming Products supplied by Kosnic, whether or not such damages are based on any warranty not explicitly mentioned herein, tort, contract or any other legal basis, even if Kosnic has been advised or is aware of such defects.

4.3 No agent, distributor or dealer is authorised to change, modify or extend the terms of this warranty on behalf of Kosnic.

5. Limitations and conditions

5.1 This warranty excludes, among other items, installation, providing access to products (scaffolding, lifts, etc.), and special, incidental and consequential damages (such as loss of revenue/profits, damage to property or other miscellaneous costs not previously mentioned), and is further defined by the limitations and conditions set forth in the warranty policy as published from time to time.

5.2 Kosnic accepts no liability for electrical supply conditions, including supply spikes, over-voltage/under-voltage and Ripple Current control systems that are beyond the specified limits of the products and those defined by relevant supply standards (e.g. EN 50160 norms).

Terms and Conditions of Sales

General

"The Company" means Kosnic Lighting Limited.

"The Conditions" means Terms and Conditions.

"The Goods" means the goods agreed to be supplied by the Company.

"The Purchaser" means any firm or company that has agreed to buy the goods.

The company reserves the right to amend the Conditions.

All quotations are made and all orders are accepted subject to these conditions.

Quotations & Orders

(a) The company reserves the right to withdraw or revise Purchaser's acceptance of a quotation unless such quotation is stated to be open within the certain period of time. Any sample submitted to the Purchaser is returnable.

(b) The company reserves the right to accept or cancel orders, as well as to cancel any uncompleted order or to suspend delivery in the event of any of the Purchaser's commitments with the Company not being met or if the Company is of the opinion that such commitment will not be met by the Purchaser.

Prices

(a) All prices quoted are net and subject to VAT, where applicable, at the standard rate as published by HMRC at the time of supply

(b) The price payable for the goods will be the price as agreed between the Company and the Purchaser or, if there is no agreement as to price, the Company's list price ruling at the date of invoice.

Payment

(a) Unless otherwise agreed in writing, payment in full is due on the date of the Goods being dispatched.

(b) A 30-day account is available (subject to acceptance of credit account application) for the Purchaser. All goods remain the property of The Company until payment is received.

(c) In the event of default in payment by the due date, the Company reserves the right to charge late payment interest on the overdue amount at the stated statutory rate per annum as published by HMRC plus the prevailing bank base rate of interest as published by HSBC Bank Plc from the point when the payment becomes overdue.

Descriptive matter and illustration

(a) All descriptions and illustrations and particulars of weights and dimensions and performance criteria issued by the Company in catalogues, price lists, advertising matter and specifications are by way of general descriptions and approximate only, and shall not form part of any contract or give rise to any liability on the part of the Company.

(b) It is the policy of the company to endeavor to develop and improve its products, and accordingly the Company reserves the right to change all specifications without prior notification or public announcement pursuant to such policy, provided that nothing in this Clause shall oblige the Purchaser to accept goods which do not reasonably comply with the contract.

Delivery

(a) The delivery fee is included in the price quoted, unless advised otherwise.

(b) All times or dates for delivery of the goods given by the Company are approximate only and shall not be of the essence of the contract.

(c) The purchaser will sign the Company's delivery note for the receipt of goods. If the Purchaser signs "unexamined" the Company will deem this to be an acknowledgement of the receipt of all pallets boxes, cartons or packages specified in the delivery note in good condition.

Storage

If the Company does not receive forwarding instructions sufficient to enable it to deliver the goods within 14 days after the date of notification to the Purchaser that they are ready for dispatch. The Company shall be entitled to arrange storage whether as its own premises or elsewhere on the Purchaser's behalf whereupon risk in the goods shall pass to the Purchaser. The purchase price of such goods shall become payable by the purchaser and all costs of storage and insurance of the goods shall be payable by the Purchaser.

Loss or damage in transit

(a) Except where the customer collects the goods from the Company, the Company will credit in full any goods damaged in transit or not delivered in accordance with the Delivery Note, provided that this has been clearly indicated on the relevant documentation at the time of delivery.

(b) Where an entire delivery has not been received the Company will credit all items in full provided that the Company has received written notification within 10 working days of the date of invoice.

Returned goods

The company only accepts returns if the goods are faulty, damaged in transit between the company and Purchaser, or if the wrong goods have been delivered. In no other circumstances will goods be accepted as returned. The cost of carriage for returns is at the expense of the Purchaser.

Force Majeure

The Company shall bear no liability for any loss or damage suffered by the Purchaser if the Company is prevented from fulfilling a Purchaser's order as a result of industrial dispute or any cause beyond its reasonable control or any liability of the Company to procure materials required for the performance of the order. The company shall suspend or make partial deliveries or extend the time or times for delivery.

Passing of property and risk

(a) The risk in the goods shall pass to the Purchaser immediately on delivery of the goods to the Purchaser.

(b) The property in the goods shall remain with the Company until all payments under the contract for the goods have been made in full and unconditionally, whilst the ownership of the Company continues the Customer shall keep the goods separate and identifiable from all other goods in its possession as Bailee of the Company.

Legal construction

All contracts to which these Conditions of Sales apply shall in all respects be construed and operate as an English contract and in conformity with English law.

Product Index

MODEL	PAGE	STOCK CODE	DESCRIPTION (SHORT)	BOX QUANTITY (inner / outer)	
Power Spot					
HaloLED	9	KCOB07DIM/GU10	7W Dimmable COB LED, GU10, 35000hrs, 2700K/5000K, 36° Beam Angle	20/100	
	9	KCOB06PWR/GU10	6W COB Retrofit GU10, 35000hrs, 2700K/5000K, 36° Beam Angle	20/100	
	9	KCOB05DIM/GU10	5W Dimmable COB LED, GU10, 35000hrs, 2700K/4000K/6500K, 36° Beam Angle	20/100	
	9	KCOB05PWR/GU10	5W COB Retrofit GU10, 30000hrs, 2700K/4000K/6500K, 36° Beam Angle	20/100	
	9	KCOB05PWR/G5.3	5W COB Retrofit G5.3, 30000hrs, 2700K/4000K/6500K, 36° Beam Angle	20/100	
	9	KCOB3.5PWR/GU10	3.5W COB Retrofit GU10, 30000hrs, 2700K/4000K/6500K, 36° Beam Angle	20/100	
Pro	10	KPRO07DIM/GU10	7W Dimmable GU10, 35000hrs, 2700K/5000K, 38° Beam Angle	20/100	
	10	KPRO07PWR/GU10	7W LED GU10, 35000hrs, 2700K/5000K, 38° Beam Angle	20/100	
	10	KPRO06DIM/GU10	6W Dimmable LED, GU10, 35000hrs, 3000K/4000K/6500K, 45° Beam Angle	20/100	
	10	KPRO06PWR/GU10	6W LED GU10, 35000hrs, 3000K/4000K/6500K, 45° Beam Angle	20/100	
	10	KPRO06PWR/G5.3	6W LED G5.3, 35000hrs, 3000K/4000K/6500K, 45° Beam Angle	20/100	
	10	KPRO4.5DIM/GU10	4.5W Dimmable LED, GU10, 35000hrs, 3000K/4000K/6500K, 45° Beam Angle	20/100	
	10	KPRO4.5PWR/GU10	4.5W LED GU10, 35000hrs, 3000K/4000K/6500K, 45° Beam Angle	20/100	
	10	KPRO4.5PWR/G5.3	4.5W LED G5.3, 35000hrs, 3000K/4000K/6500K, 45° Beam Angle	20/100	
	10	KPRO3.5PWR/GU10	3.5W LED GU10, 35,000hrs, 3000K/4000K/6500K, 45° Beam Angle	20/100	
	HiLux	11	KSMD06DIM/GU10	6W Dimmable SMD LED GU10, 30000hrs, 3000K/4000K/6500K, 60° Beam Angle	20/100
11		KSMD06PWR/GU10	6W SMD LED GU10, 30000hrs, 3000K/4000K/6500K, 60° Beam Angle	20/100	
11		KSMD05DIM/GU10	5W Dimmable SMD LED GU10, 30000hrs, 3000K/4000K/6500K, 60° Beam Angle	20/100	
11		KSMD05PWR/GU10	5W SMD LED GU10, 30000hrs, 3000K/4000K/6500K, 60° Beam Angle	20/100	
11		KSMD05PWR/G5.3	5W SMD LED G5.3, 30000hrs, 3000K/4000K/6500K, 60° Beam Angle	20/100	
11		KSMD04PWR/GU10-F	4W SMD LED GU10, 30000hrs, 3000K/4000K/6500K, 60° Beam Angle	20/100	
11		KSMD04PWR/GU10-W	4W SMD LED GU10, 30000hrs, 3000K/4000K/6500K, 100° Beam Angle	20/100	
11		KSMD2.5PWR/GU10-F	2.5W SMD LED GU10, 30000hrs, 3000K/4000K/6500K, 60° Beam Angle	20/100	
11		KSMD2.5PWR/GU10-W	2.5W SMD LED GU10, 30000hrs, 3000K/4000K/6500K, 100° Beam Angle	20/100	
Display		12	KTC15AR111/GU10	15W LED ES111, 30000hrs, 3000K/6000K	50
		12	KTC15AR111/G53	15W LED AR111, 30000hrs, 3000K/6000K	50
	12	KTC15P38/E27	15W LED PAR38, 30000hrs, 3000K/5000K	20	
	12	KTC10P30/E27	10W LED PAR38, 30000hrs, 3000K/5000K	50	
	12	KDIM05P16/E14	5W Dimmable LED PAR16, 30000hrs, 3000K/6500K	20/100	
	12	KTC05P16/E14	5W LED PAR16, 30000hrs, 3000K/6500K	20/100	
	12	KTC04MR11/GU4	4W LED MR11, 30000hrs, 3000K/6500K	100/200	
	12	KTC02MR11/GU4	2W LED MR11, 30000hrs, 3000K/6500K	36/180	
Filament					
Filament	13	KFLM02CND-CLR	2W LED Filament Candle, B22/E14/E27, 20000hrs, 2700K	25/100	
	13	KFLM04CND-CLR	4W LED Filament Candle, B22/E14/E27, 20000hrs, 2700K	10/50	
	13	KFLM02BTP-CLR	2W LED Filament Candle, Bent-tip, B22/E14/E27, 20000hrs, 2700K	25/100	
	13	KFLM04BTP-CLR	4W LED Filament Candle, Bent-tip, B22/E14/E27, 20000hrs, 2700K	10/50	
	13	KFLM02TWT-CLR	2W LED Filament Candle, Twisted, B22/E14/E27, 20000hrs, 2700K	10/50	
	13	KFLM04TWT-CLR	4W LED Filament Candle, Twisted, B22/E14/E27, 20000hrs, 2700K	10/50	
	13	KFLM02GLF-CLR	2W LED Filament Golf, B22/E14/E27, 20000hrs, 2700K	10/50	
	13	KFLM04GLF-CLR	4W LED Filament Golf, B22/E14/E27, 20000hrs, 2700K	10/50	
	14	KFLM4.5GLS-CLR	4.5W LED Filament GLS lamp, B22/E27, 20000hrs, 2700K	10/50	
	14	KFLM07GLS-CLR	7W LED Filament GLS lamp, B22/E27, 20000hrs, 2700K	10/50	
	14	KFLM4.5GLB-CLR	4.5W LED Filament Globe lamp, B22/E27, 20000hrs, 2700K	10/20	
	14	KFLM02CND-FRS	2W LED Filament Frosted Candle, B22/E14/E27, 20000hrs, 2700K	25/100	
	14	KFLM04CND-FRS	4W LED Filament Frosted Candle, B22/E14/E27, 20000hrs, 2700K	25/100	
	14	KFLM4.5GLS-FRS	4.5W LED Filament Frosted GLS lamp, B22/E27, 20000hrs, 2700K	25/50	
	14	KFLM07GLS-FRS	7W LED Filament Frosted GLS lamp, B22/E27, 20000hrs, 2700K	25/50	
	14	KFLM4.5GLB-FRS	4.5W LED Filament Frosted Globe lamp, B22/E27, 20000hrs, 2700K	15	

MODEL	PAGE	STOCK CODE	DESCRIPTION (SHORT)	BOX QUANTITY (inner / outer)	
Antique Filament	15	KFLM02CND-GLD	2W LED Filament Candle, B22/E14/E27, C35 Gold finish, 20000hrs, 2700K	10/50	
	15	KFLM04CND-GLD	4W LED Filament Candle, B22/E14/E27, C35 Gold finish, 20000hrs, 2700K	10/50	
	15	KFLM02BTP-GLD	2W LED Filament Candle, Bent-tip, B22/E14/E27, Gold finish, 20000hrs, 2700K	10/50	
	15	KFLM04BTP-GLD	4W LED Filament Candle, Bent-tip, B22/E14/E27, Gold finish, 20000hrs, 2700K	10/50	
	15	KFLM04TWT-GLD	4W LED Filament Candle, Twisted, B22/E14/E27, Gold finish, 20000hrs, 2700K	10/50	
	16	KFLM04GLS-GLD	4W LED Filament GLS lamp, B22/E27, Gold finish, 20000hrs, 2700K	10/50	
	16	KFLM02G100-GLD	2W LED Filament, Globe, B22/E27, G100 Gold finish, 20000hrs, 2700K	15	
	16	KFLM04G100-GLD	4W LED Filament, Globe, B22/E27, G100 Gold finish, 20000hrs, 2700K	15	
	16	KFLM02G125-GLD	2W LED Filament, Globe, B22/E27, G125 Gold finish, 20000hrs, 2700K	15	
	16	KFLM04G125-GLD	4W LED Filament, Globe, B22/E27, G125 Gold finish, 20000hrs, 2700K	15	
	16	KFLM02ST64-GLD	2W LED Filament, ST64, B22/E27, Gold finish, 20000hrs, 2700K	10/50	
	16	KFLM04ST64-GLD	4W LED Filament, ST64, B22/E27, Gold finish, 20000hrs, 2700K	10/50	
	Home				
	Décor Candle and Golf	17	KDIM04CND	4W Dimmable LED Candle, B22/E14/E27, 30000hrs, 2700K, Silver Finish	25/100
		17	KTC04CND	4W LED Candle, B22/E14/E27, 30000hrs, 2700K, Silver Finish	25/100
		17	KDIM5.5CND	5.5W Dimmable LED Candle, B15/B22/E14/E27, 30000hrs, 2700K, Silver/Brass/Bronze Finish	25/100
17		KTC5.5CND	5.5W LED Candle, B15/B22/E14/E27, 30000hrs, 2700K, Silver/Brass/Bronze Finish	25/100	
17		KDIM5.5GLF	5.5W Dimmable LED Golf, B22/E27/E14, 30000hrs, 2700K, Silver Finish	25/100	
17		KTC5.5GLF	5.5W LED Golf, B22/E27/E14, 30000hrs, 2700K, Silver Finish	25/100	
18		KDIM5.5BTP	5.5W Dimmable LED Candle, E14, Bent-tip, 30000hrs, 2700K, Silver/Brass/Bronze Finish	25/100	
18		KTC5.5BTP	5.5W LED Candle, E14, Bent-tip, 30000hrs, 2700K, Silver/Brass/Bronze Finish	25/100	
18		KDIM5.5TWT	5.5W Dimmable LED Candle, E14, Twisted, 30000hrs, 2700K, Silver/Brass/Bronze Finish	25/100	
18		KTC5.5TWT	5.5W LED Candle, E14, Twisted, 30000hrs, 2700K, Silver/Brass/Bronze Finish	25/100	
GLS	19	KDIM12GLS	12W Dimmable GLS LED, B22/E27, 30000hrs, 3000K/4000K/6500K	25/50	
	19	KDIM10GLS	10W Dimmable GLS LED, B22/E27, 30000hrs, 3000K/4000K/6500K	25/50	
	19	KDIM08GLS	8W Dimmable GLS LED, B22/E27, 30000hrs, 3000K/4000K/6500K	25 / 50	
	19	KDIM06GLS	6W Dimmable GLS LED, B22/E27, 30000hrs, 3000K/4000K/6500K	25/50	
	19	KTC13.5GLS	13.5W GLS LED, B22/E27, 30000hrs, 3000K/4000K/6500K	25/50	
	19	KTC12GLS	12W GLS LED, B2/E272, 30000hrs, 3000K/4000K/6500K	25/50	
	19	KTC10GLS	10W GLS LED, B22/E27, 30000hrs, 3000K/4000K/6500K	25/50	
	19	KTC08GLS	8W GLS LED, B22/E27, 30000hrs, 3000K/4000K/6500K	25/50	
	19	KTC06GLS	6W GLS LED, B22/E27, 30000hrs, 3000K/4000K/6500K	25/50	
	GX53, G9, G4	20	KLED07DSK	7W LED Disk, GX53, 30000hrs, 3000K/6000K	50/100
20		KLED05DSK	5W LED Disk, GX53, 30000hrs, 3000K/6000K	50/100	
20		KLED03DSK	3W LED Disk, GX53, 30000hrs, 3000K/6000K	50/100	
20		KLED07LNR/R7S	7W R7S 240V, 150° Beam Angle, 30000hrs, 6500K	144	
20		KLED3.5CPL/G9	3.5W LED G9 Capsule Lamp, 30000hrs, 3000K/6500K	50/500	
20		KTC02CPL/G9	2W LED G9 Capsule Lamp, 30000hrs, 3000K/6500K	50/200	
20		KLED1.5CPL/G4	1.5W LED 12V G4 Capsule Lamp, 30000hrs, 3000K	100/500	
20		KLED1.2CPL/G4	1.2W LED 12V G4 Capsule Lamp, 30000hrs, 3000K	100/500	
ReonLED					
ReonLED (GLS, Candle and Golf)		21	RLCND06	7W Reon LED Candle, Frosted, B22/E14/E27, 20000hrs, 3000K	10/50
	21	RDCND05	5W Dimmable Reon LED Candle, B22/E14/E27, 20000hrs, 3000K	10/100	
	21	RLCND05	5W Reon LED Candle, Frosted, B15/B22/E14/E27, 20000hrs, 3000K/4000K/6500K	10/50	
	21	RLCND04	4W Reon LED Candle, Frosted, B22/E14/E27, 20000hrs, 3000K/4000K/6500K	20/100	
	21	RLCND03	3W Reon LED Candle, Frosted, B22/E14/E27, 20000hrs, 3000K	20/100	
	21	RLCCN05	5W Reon LED Candle, Clear, B22/E14/E27, 20000hrs, 3000K	10/100	
	21	RLCCN04	4W Reon LED Candle, Clear, B22/E14/E27, 20000hrs, 3000K	10/100	
	21	RLCCN03	3W Reon LED Candle, Clear, B22/E14/E27, 20000hrs, 3000K/6500K	25/100	
	22	RLGLF05	5W Reon LED Golf, B22/E14/E27, 20000hrs, 3000K/6500K	10/50	
	22	RLGLF04	4W Reon LED Golf, B22/E14/E27, 20000hrs, 3000K	20/100	
	22	RLGLS11	11W Reon LED GLS, B22/E27, 20000hrs, 3000K	10/50	
	22	RLGLS09	9W Reon LED GLS, B22/E27, 20000hrs, 3000K/4000K/6500K	10/50	

MODEL	PAGE	STOCK CODE	DESCRIPTION (SHORT)	BOX QUANTITY (inner / outer)
	22	RLGLS07	7W Reon LED GLS, B22/E27, 20000hrs, 3000K/4000K/6500K	10/50
	22	RLGLS05	5W Reon LED GLS, B22/E27, 20000hrs, 3000K	10/50
	22	RLGLB11	11W Reon Globe, B22/E27, 20000hrs, 3000K	15
ReonLED (Reflectors)	23	RLECOB05	5W Reon LED COB, GU10, 20000hrs, 3000K/6500K	10/50
	23	RDCOB05	5W Dimmable Reon LED COB, GU10, 20000hrs, 3000K/6500K	10/50
	23	RLECO4	4W Reon LED SMD GU10, 20000hrs, 3000K/6500K	16/80
	23	RLECO3	3W Reon LED SMD GU10, 20000hrs, 3000K/6500K	16/80
	23	RLR5004	4W Reon Reflector LED R50, E14, 20000hrs, 3000K	25/50
	23	RLR6306	6W Reon Reflector LED R63, E27, 20000hrs, 3000K	25/50
	23	RLR8008	8W Reon Reflector LED R80, E27, 20000hrs, 3000K	25/50
ReonLED (PAR Reflectors)	24	RLP2007	7W Reon LED Par 20, E27, 20000hrs, 3000K	*
	24	RLP3009	9W Reon LED Par 30, E27, 20000hrs, 3000K	*
	24	RLP3811	11W Reon LED Par 38, E27, 20000hrs, 3000K	*
Commercial				
LED DD	25	KHV14STD	14W High Voltage LED DD, 30000hrs, 4000K	10/20
	25	KLED18STD	18W LED DD Standard, 4pin, 30000hrs, 2700K/4000K/6500K	10/20
	25	KLED12STD	12W LED DD Standard, 2pin/4pin, 30000hrs, 2700K/4000K/6500K	10/20
	25	KLED09STD	9W LED DD Standard, 2pin/4pin, 30000hrs, 4000K	10/20
LED DD (Sensor with Corridor Function)	26	KLED12CRD	12W LED DD, Integrated Motion Sensor and Corridor Function, 4pin, 30000hrs, 4000K	10/20
	26	KLED18CRD	18W LED DD, Integrated Motion Sensor and Corridor Function, 4pin, 30000hrs, 4000K	10/20
LED T8	27	KPRO08T8	8W LED Glass T8, 2ft, 40000hrs, 4000K/6500K, Frosted	25
	27	KPRO17T8	17W LED Glass T8, 4ft, 40000hrs, 4000K/6500K, Frosted	25
	27	KPRO25T8	25W LED Glass T8, 5ft, 40000hrs, 4000K/6500K, Frosted	25
	27	KPRO30T8	30W LED Glass T8, 6ft, 40000hrs, 4000K/6500K, Frosted	25
	27	KHV10T8-FRO	10W LED T8 Tube, 30000hrs, 4000K/6500K	25
	27	KHV20T8-FRO	20W LED T8 Tube, 30000hrs, 4000K/6500K	25
	27	KHV25T8-FRO	25W LED T8 Tube, 30000hrs, 4000K/6500K	16
	27	KTC35T8-FRO	35W LED T8 Tube, 30000hrs, 4000K/6500K	16
Effect				
Effect	28	KSTRO1GLF	1W LED Golf, B22/E27, Clear, White/Blue/Green/Orange/Red/Yellow	10/50
	28	KLED01GLF-W	1W LED Golf, B22/E27, 8 LEDs, Opal Plastic Cover, White, 4000K	10/50
	28	KLED01GLF	1W LED Golf, B22/E27, 8 LEDs, Opal Plastic Cover, Blue/Green/Red/Yellow	10/50
	28	KLED1.5HIO/GU10	1.5W LED GU10 (High-output), 12 LEDs, White/Blue/Green/Orange/Red/Yellow	20/100
	28	KLED2.0HIO/GU10	2W LED GU10, (High-output), 18 LEDs, White/Blue	20/100
	28	KLED2.0HIO/G5.3	2W LED G5.3, (High-output), 18 LEDs, White, White/Blue	20/100
Panel				
Standard	31	KLED30PNL	30W LED Panel, 600mmX600mm, 40000hr, 120° Beam Angle, 3000K/4000K/6500K, Silver/White frame	2
	31	KLED30PNL/T	30W LED Panel, 600mmX600mm, 40000hr, 120° Beam Angle, 3000K/4000K/6500K, Ripple free driver	2
	31	KLED30PNL/DD	30W LED Panel, 600mmX600mm, 40000hr, 120° Beam Angle, 3000K/4000K/6500K, DALI Dimmable	2
	31	KLED40PNL	40W LED Panel, 600mmX600mm, 40000hr, 120° Beam Angle, 4000K/6500K	2
	31	KLED40PNL/DD	40W LED Panel, 600mmX600mm, 40000hr, 120° Beam Angle, 4000K/6500K, DALI Dimmable	2
	31	KLED40PNL/AD	40W LED Panel, 600mmX600mm, 40000hr, 120° Beam Angle, 4000K/6500K, 1-10V dimming	2
	31	KLED30PNL0505	30W LED Panel, 495mmX495mm, 40000hrs, 120° Beam Angle, 4000K/6500K	2
	31	KLED30PNL0505/DD	30W LED Panel, 495mmX495mm, 40000hrs, 120° Beam Angle, 4000K/6500K, DALI Dimmable	2
Pro	32	KLED36PNL	36W LED Panel, 600mmX600mm, 40000hr, 120° Beam Angle, 4000K/6500K	2
	32	KLED36PNL/DD	36W LED Panel, 600mmX600mm, 40000hr, 120° Beam Angle, 4000K/6500K, DALI Dimmable	2
	32	KLED36PNL/AD	36W LED Panel, 600mmX600mm, 40000hr, 120° Beam Angle, 4000K/6500K, 1-10V dimming	2
	32	KLED45PNL	45W LED Panel, 600mmX600mm, 40000hr, 120° Beam Angle, 4000K/6500K	2
	32	KLED45PNL/DD	45W LED Panel, 600mmX600mm, 40000hr, 120° Beam Angle, 4000K/6500K, DALI Dimmable	2

MODEL	PAGE	STOCK CODE	DESCRIPTION (SHORT)	BOX QUANTITY (inner / outer)
	32	KLED45PNL/AD	45W LED Panel, 600mmX600mm, 40000hr, 120° Beam Angle, 4000K/6500K, 1-10V dimming	2
	32	KLED80PNL	80W LED Panel, 1200mmX600mm, 40000hr, 120° Beam Angle, 4000K/6500K	2
	32	KLED80PNL/DD	80W LED Panel, 1200mmX600mm, 40000hr, 120° Beam Angle, 4000K/6500K, DALI Dimmable	2
	32	KLED80PNL/AD	80W LED Panel, 1200mmX600mm, 40000hr, 120° Beam Angle, 4000K/6500K, 1-10V dimming	2
	32	KPNLLS30LT-1203	30W LED Panel, 1200mmX300mm, 40000hrs, 120° Beam Angle, 4000K	2
	32	KPNLLS30LT-1203/DD	30W LED Panel, 1200mmX300mm, 40000hrs, 120° Beam Angle, 4000K, DALI Dimmable	2
	32	KLED36PNL0303	36W LED Panel, 300mmX300mm, 40000hrs, 120° Beam Angle, 4000K	2
	32	KLED36PNL0303/DD	36W LED Panel, 300mmX300mm, 40000hrs, 120° Beam Angle, 4000K, DALI Dimmable	2
	32	KLED36PNL0303/AD	36W LED Panel, 300mmX300mm, 40000hrs, 120° Beam Angle, 4000K, 1-10V dimming	2
Twin Bar (with PIR option)	33	KTWB30PNL	30W Twin Bar Panel, 600mm x 600mm, 40000hrs, 120° Beam Angle, 4000K/6500K	2
	33	KTWB40PNL	40W Twin Bar LED Panel, 600mmX600mm, 40000hrs, 120° Beam Angle, 4000K/6500K	2
	33	KTWB30PNL/T	30W Twin Bar LED Panel, 600mmX600mm, 40000hrs, 120° Beam Angle, 4000K/6500K, Ripple free driver	2
	33	KTWB40PNL/T	40W Twin Bar LED Panel, 600mmX600mm, 40000hrs, 120° Beam Angle, 4000K/6500K, Ripple free driver	2
	33	KTWB30PNL/DD	30W Twin Bar LED Panel, 600mmX600mm, 40000hrs, 120° Beam Angle, 4000K/6500K, DALI Dimmable	2
	33	KTWB40PNL/DD	40W Twin Bar LED Panel, 600mmX600mm, 40000hrs, 120° Beam Angle, 4000K/6500K, DALI Dimmable	2
	33	KTWB30PNL/AD	30W Twin Bar LED Panel, 600mmX600mm, 40000hrs, 120° Beam Angle, 4000K/6500K, 1-10V dimming	2
	33	KTWB40PNL/AD	40W Twin Bar LED Panel, 600mmX600mm, 40000hrs, 120° Beam Angle, 4000K/6500K, 1-10V dimming	2
	33	KTWB30PNL/S	30W Twin Bar Panel, 600mm x 600mm, 40000hrs, 4000K/6500K, 120° Beam Angle, with PIR Sensor	2
	33	KTWB30PNL/SD	30W Twin Bar Panel, 600mm x 600mm, 40000hrs, 4000K/6500K, 120° Beam Angle, with PIR Sensor and dimming function	2
	33	KTWB30PNL/S/T	30W Twin Bar Panel, 600mm x 600mm, 40000hrs, 4000K/6500K, 120° Beam Angle, with PIR Sensor, Ripple free driver	2
	33	KTWB30PNL/SD/T	30W Twin Bar Panel, 600mm x 600mm, 40000hrs, 4000K/6500K, 120° Beam Angle, with PIR Sensor and dimming function, Ripple free driver	2
	33	KTWB30PNL/S/AD	30W Twin Bar Panel, 600mm x 600mm, 40000hrs, 4000K/6500K, 120° Beam Angle, with PIR Sensor, 1-10V dimmable	2
	33	KTWB30PNL/SD/AD	30W Twin Bar Panel, 600mm x 600mm, 40000hrs, 4000K/6500K, 120° Beam Angle, with PIR Sensor and dimming function, 1-10V dimmable	2
Modular Luminaires				
Kurve LED Modular Luminaire	34	KMRC45L1A	Kurve-1, 45W LED Modular Luminaire, 600mmX600mm, 40000hrs, 4000K/6500K	1/1
	34	KMRC45L2A	Kurve-2, 45W LED Modular Luminaire, 600mmX600mm, 40000hrs, 4000K/6500K	1/1
	34	KMRC45L1A/DD	Kurve-1, 45W LED Modular Luminaire, 600mmX600mm, 40000hrs, 4000K/6500K, DALI dimmable	1/1
	34	KMRC45L2A/DD	Kurve-2, 45W LED Modular Luminaire, 600mmX600mm, 40000hrs, 4000K/6500K, DALI dimmable	1/1
	34	KMRC45L1A/AD	Kurve-1, 45W LED Modular Luminaire, 600mmX600mm, 40000hrs, 4000K/6500K, 1-10V dimming	1
	34	KMRC45L2A/AD	Kurve-2, 45W LED Modular Luminaire, 600mmX600mm, 40000hrs, 4000K/6500K, 1-10V dimming	1
	34	KMRC45L1A/E	Kurve-1, 45W LED Modular Luminaire, 600mmX600mm, 40000hrs, 4000K/6500K, Emergency	1
	34	KMRC45L2A/E	Kurve-2, 45W LED Modular Luminaire, 600mmX600mm, 40000hrs, 4000K/6500K, Emergency	1
	35	KMRC30L3A	Kurve-3, 30W LED Modular Luminaire, 600mmX600mm, 40000hrs, 4000K/6500K	1/2
	35	KMRC30L3A/T	Kurve-3, 30W LED Modular Luminaire, 600mmX600mm, 40000hrs, 4000K/6500K, Ripple free driver	1
	35	KMRC30L3A/DD	Kurve-3, 30W LED Modular Luminaire, 600mmX600mm, 40000hrs, 4000K/6500K, DALI Dimmable	1
	35	KMRC30L3A/AD	Kurve-3, 30W LED Modular Luminaire, 600mmX600mm, 40000hrs, 4000K/6500K, 1-10V dimming	1

MODEL	PAGE	STOCK CODE	DESCRIPTION (SHORT)	BOX QUANTITY (Inner / outer)	
Pyramid	36	KPYD36PNL	36W LED Pyramid Luminaire, 4000hrs, 4000k	1	
	36	KPYD36PNL/DD	36W LED Pyramid Luminaire, 4000hrs, 4000k, DALI Dimmable	1	
	36	KPYD36PNL/AD	36W LED Pyramid Luminaire, 4000hrs, 4000k, 1-10V dimming	1	
Fixings					
Panel Mounting Kits	31-34	KPTPNL/SMT	LED Panel Surface Mount Fixing	10	
	31-34	KPTPNL/SMT-ECO1	Panel Accessories, Surface Mounted, ECO1 Version	10	
	31-34	KPTPNL/SMT-ECO2	Panel Accessories, Surface Mounted, ECO2 Version	10	
	31-34	KPTPNL/SUS	LED Panel Suspended Fixing	20	
Surface-Mount Circular Panel	37	KPNLLS25CS	25W LED Surface-Mount Circular Panel, 4000hrs, 4000K	1/4	
	37	KPNLLS30CS	30W LED Surface-Mount Circular Panel, 4000hrs, 4000K	1/2	
	37	KPNLLS35CS	35W LED Surface-Mount Circular Panel, 4000hrs, 4000K	1/2	
IP65 Utility Bulkhead	38	KBHDDC1S65	Opal Industrial LED Bulkhead, IP65	10	
	38	KBHDDC1S65/E	Opal Industrial LED Bulkhead, IP65 with Built-in Emergency Module	10	
	38	KBHCT14C1S65	14W Standard IP65 Industrial LED Bulkhead with Dedicated LED Tray,	16	
	38	KBHCT14C1S65/E	14W Emergency IP65 Industrial LED Bulkhead with Dedicated LED Tray	16	
IP65 Polo Bulkhead	39	KBHDDC2S65-WHT	Opal Decorative LED Bulkhead, IP65, White Finish	10	
	39	KBHDDC2S65-BAS	Opal Decorative LED Bulkhead, IP65, , Brass Finish	10	
	39	KBHDDC2S65-CHM	Opal Decorative LED Bulkhead, IP65, Chrome Finish	10	
	39	KBHDDC2S65/E-WHT	Opal Decorative LED Bulkhead, IP65 with Built-in Emergency Module, White Finish	10	
	39	KBHDDC2S65/E-BAS	Opal Decorative LED Bulkhead, IP65 with Built-in Emergency Module, Brass Finish	10	
	39	KBHDDC2S65/E-CHM	Opal Decorative LED Bulkhead, IP65 with Built-in Emergency Module, Chrome Finish	10	
	39	KBHCT14C2S65-W40-WHT	14W Standard IP65 Decorative LED Bulkhead with Dedicated LED Tray, White Finish	10	
	39	KBHCT14C2S65-W40-BAS	14W Standard IP65 Decorative LED Bulkhead with Dedicated LED Tray, Brass Finish	10	
	39	KBHCT14C2S65-W40-CHM	14W Standard IP65 Decorative LED Bulkhead with Dedicated LED Tray, Chrome Finish	10	
	39	KBHCT14C2S65/E-W40-WHT	14W Emergency IP65 Decorative LED Bulkhead with Dedicated LED Tray, White Finish	10	
	39	KBHCT14C2S65/E-W40-BAS	14W Emergency IP65 Decorative LED Bulkhead with Dedicated LED Tray, Brass Finish	10	
	39	KBHCT14C2S65/E-W40-CHM	14W Emergency IP65 Decorative LED Bulkhead with Dedicated LED Tray, Chrome Finish	10	
	LED Wall Pack	40	KBHLS50QS65	50W Integrated LED Rectangular IP65 Bulkhead, 4000hrs, 5000K	1
	Fire Rated Downlight				
Fire Rated Downlight	41	KFDLGU10F	Fire-Rated Can, compatible with Kosnic Retrofit GU10 Lamps, White/Silver/Chrome finish	60	
MagFit Fire Rated Downlight	42	KFDLGU10F1-WHT	Fire-Rated Can, compatible with Kosnic Retrofit GU10 Lamps, interchangeable bezel, comes with IP20 white bezel	1/40	
	42	KPT-BZPK20-SC	IP20 Silver and Chrome bezel pack	40/80	
	42	KPT-BZ44	IP44 White/Silver/Chrome magnetic bezel (1pc)	40/80	
	43	KFDL07F1-WHT/D	Fire-Rated Can, interchangeable bezel, comes with IP20 white bezel, prefitted with KCOB07DIM/GU10-S27/S50	1/40	
	43	KFDL06F1-WHT	Fire-Rated Can, interchangeable bezel, comes with IP20 white bezel, prefitted with KCOB06PWR/GU10-S27/S50	1/40	
	43	KFDL05F1-WHT/D	Fire-Rated Can, interchangeable bezel, comes with IP20 white bezel, prefitted with KCOB05DIM/GU10-S27	1/40	
	43	KFDL05F1-WHT	Fire-Rated Can, interchangeable bezel, comes with IP20 white bezel, prefitted with KCOB05PWR/GU10-S27	1/40	
Downlight					
HaloLED Downlight	44	KSDLLC08FF	8W HaloLED Fixed Downlight, 35000hrs, 27000K/4000K/6500K, White/Chrome/Silver, 35mm depth	1/60	
	44	KSDLLC08FF/DIM	8W Dimmable HaloLED Fixed Downlight, 35000hrs, 27000K/4000K/6500K, White/Chrome/Silver, 35mm depth	1/60	
	44	KSDLLC08TF	8W HaloLED Tilt Downlight, 35000hrs, 27000K/4000K/6500K, White/Chrome/Silver, 35mm depth	1/60	
	44	KSDLLC08TF/DIM	8W Dimmable HaloLED Tilt Downlight, 35000hrs, 27000K/4000K/6500K, White/Chrome, Silver, 35mm depth	1/60	
Commercial Downlight					
Faceted	45	KCDLLS08FR	8W LED Commercial Downlight, 3", 4000hrs, 4000K, Faceted White	1/12	

MODEL	PAGE	STOCK CODE	DESCRIPTION (SHORT)	BOX QUANTITY (inner / outer)	
	45	KCDLLS08FR/AD	8W LED Commercial Downlight, 3", 4000hrs, 4000K, Faceted White, 1-10V dimming	1/12	
	45	KCDLLS10FR	10W LED Commercial Downlight, 4", 4000hrs, 4000K, Faceted White	1/12	
	45	KCDLLS10FR/AD	10W LED Commercial Downlight, 4", 4000hrs, 4000K, Faceted White, 1-10V dimming	1/12	
	45	KCDLLS16FR	16W LED Commercial Downlight, 6", 4000hrs, 4000K, Faceted White	1/12	
	45	KCDLLS16FR/DD	16W LED Commercial Downlight, 6", 4000hrs, 4000K, Faceted White, DALI Dimmable	1/12	
	45	KCDLLS16FR/AD	16W LED Commercial Downlight, 6", 4000hrs, 4000K, Faceted White, 1-10V dimming	1/12	
	45	KCDLLS24FR	24W LED Commercial Downlight, 8", 4000hrs, 4000K, Faceted White	1/12	
	45	KCDLLS24FR/DD	24W LED Commercial Downlight, 8", 4000hrs, 4000K, Faceted White, DALI Dimmable	1/12	
	45	KCDLLS24FR/AD	24W LED Commercial Downlight, 8", 4000hrs, 4000K, Faceted White, 1-10V dimming	1/12	
Pro	46	KPDLHS10CR65	10W (4") LED Pro Commercial Downlight , 4000hrs, 4000K	1/12	
	46	KPDLHS16CR65	16W (6") LED Pro Commercial Downlight , 4000hrs, 4000K	1/12	
	46	KPDLHS24CR65	24W (8") LED Pro Commercial Downlight , 4000hrs, 4000K	1/12	
Standard	47	KSDLHS10CF	10W (4") LED Standard Commercial Downlight , 4000hrs, 4000K	1/12	
	47	KSDLHS16CF	16W (6") LED Standard Commercial Downlight , 4000hrs, 4000K	1/12	
	47	KSDLHS23CF	23W (8") LED Standard Commercial Downlight , 4000hrs, 4000K	1/12	
Circular Panel (Edge-Lit)	48	KPNLLS10CF	10W (4") LED Circular panel, 4000hrs, 4000K	1/10	
	48	KPNLLS12CF	12W (6") LED Circular panel, 4000hrs, 4000K	1/10	
	48	KPNLLS18CF	18W (8") LED Circular panel, 4000hrs, 4000K	1/10	
	48	KPNLLS18CF/DD	18W (8") LED Circular panel, 4000hrs, 4000K, DALI Dimmable	1/10	
	48	KPNLLS18CF/AD	18W (8") LED Circular panel, 4000hrs, 4000K, 1-10V dimming	1/10	
	Floodlight				
LED Floodlight (with PIR option)	49	KFLDHS10Q65	10W LED Floodlight, 4000hrs, 3000K/6500K, Black/White	20	
	49	KFLDHS20Q65	20W LED Floodlight, 4000hrs, 3000K/6500K, Black	20	
	49	KFLDHS30Q65	30W LED Floodlight, 4000hrs, 3000K/6500K, Black	20	
	49	KFLDHS50Q65	50W LED Floodlight, 4000hrs, 6500K, Black	20	
	49	KFLDHS10Q54/S	10W LED PIR Sensor Floodlight, 4000hrs, 3000K/6500K	20	
	49	KFLDHS20Q54/S	20W LED PIR Sensor Floodlight, 4000hrs, 3000K/6500K	20	
	49	KFLDHS30Q54/S	30W LED PIR Sensor Floodlight, 4000hrs, 3000K/6500K	20	
	49	KPT-PIR-FLD	PIR Sensor to suit Kosnic LED Floodlights	1/100	
	LED Floodlight	50	KFLDHS80Q65	80W LED Floodlight, 4000hrs, 6500K, Black	1/4
		50	KFLDHS100Q65	100W LED Floodlight, 4000hrs, 6500K, Black	1/2
Batten					
Integrated Anti-Corrosive LED Batten	51	KBTN30L65	30W Anti-Corrosive Batten, IP65, 30000hrs, 4000K/6500K	10	
	51	KBTN50L65	50W Anti-Corrosive Batten, IP65, 30000hrs, 4000K/6500K	10	
	51	KBTN70L65	70W Anti-Corrosive Batten, IP65, 30000hrs, 4000K/6500K	10	
LED Anti-Corrosive Batten	52	KBTNHS50L65	50W LED Batten, IP65, 40000hrs, 4000K	1	
	52	KBTNHS50L65/S	50W LED Batten, IP65, 40000hrs, 4000K, with sensor	1	
	52	KBTNHS50L65/E	50W LED Batten, IP65, 40000hrs, 4000K, emergency version	1	
	52	KBTNHS50L65/ES	50W LED Batten, IP65, 40000hrs, 4000K, with sensor and emergency	1	
	52	KBTNHS70L65	70W LED Batten, IP65, 40000hrs, 4000K	1	
	52	KBTNHS70L65/S	70W LED Batten, IP65, 40000hrs, 4000K, with sensor	1	
	52	KBTNHS70L65/E	70W LED Batten, IP65, 40000hrs, 4000K, emergency version	1	
	52	KBTNHS70L65/ES	70W LED Batten, IP65, 40000hrs, 4000K, with sensor and emergency	1	
Anti-Corrosive Batten (For LED T8)	53	KBNT8LS654F1	4ft IP65 Batten fitting, comes with 1 x KHV20T8/FRO-W40	8	
	53	KBNT8LS654F2	4ft IP65 Batten fitting, comes with 2 x KHV20T8/FRO-W40	4	
	53	KBNT8LS655F1	5ft IP65 Batten fitting, comes with 1 x KHV25T8/FRO-W40	8	
	53	KBNT8LS655F2	5ft IP65 Batten fitting, comes with 2 x KHV25T8/FRO-W40	4	
Interior Batten (Integrated LED)	54	KBTNHS20LS1	4ft 20W Interior Batten, IP20, 40000hrs, 4000K	1	
	54	KBTNHS40LS1	5ft 40W Interior Batten, IP20, 40000hrs, 4000K	1	
	54	KBTNHS60LS1	6ft 60W Interior Batten, IP20, 40000hrs, 4000K	1	
	54	KBTNHS20LS1/S	4ft 20W Interior Batten, IP20, 40000hrs, 4000K, with sensor	1	

MODEL	PAGE	STOCK CODE	DESCRIPTION (SHORT)	BOX QUANTITY (inner / outer)
	54	KBTNHS40LS1/S	5ft 40W Interior Batten, IP20, 40000hrs, 4000K, with sensor	1
	54	KBTNHS60LS1/S	6ft 60W Interior Batten, IP20, 40000hrs, 4000K, with sensor	1
	54	KBTNHS20LS1/E	4ft 20W Interior Batten, IP20, 40000hrs, 4000K, emergency version	1
	54	KBTNHS40LS1/E	5ft 40W Interior Batten, IP20, 40000hrs, 4000K, emergency version	1
	54	KBTNHS60LS1/E	6ft 60W Interior Batten, IP20, 40000hrs, 4000K, emergency version	1
	54	KBTNHS20LS/S/E	4ft 20W Interior Batten, IP20, 40000hrs, 4000K, with sensor and emergency	1
	54	KBTNHS40LS1/S/E	5ft 40W Interior Batten, IP20, 40000hrs, 4000K, with sensor and emergency	1
	54	KBTNHS60LS1/S/E	6ft 60W Interior Batten, IP20, 40000hrs, 4000K, with sensor and emergency	1
	54	KBTNHS50LS1	4ft High Output 50W Interior Batten, IP20, 40000hrs, 4000K	1
	54	KBTNHS70LS1	5ft High Output 70W Interior Batten, IP20, 40000hrs, 4000K	1
	54	KBTNHS100LS1	6ft High Output 100W Interior Batten, IP20, 40000hrs, 4000K	1
	54	KBTNHS50LS1/S	4ft High Output 50W Interior Batten, IP20, 40000hrs, 4000K, with sensor	1
	54	KBTNHS70LS1/S	5ft High Output 70W Interior Batten, IP20, 40000hrs, 4000K, with sensor	1
	54	KBTNHS100LS1/S	High Output 100W Interior Batten, IP20, 40000hrs, 4000K, with sensor	1
Slim-Line Interior LED Batten	55	KBTNHS30LS2	30W Interior Batten, IP20, 40000hrs, 4000K	1
	55	KBTNHS45LS2	45W Interior Batten, IP20, 40000hrs, 4000K	1
Standard Batten (for LED T8)	56	KBTNT8LS202F1	2ft IP20 Batten fitting, comes with 1 x KHV10T8/FRO-W40	1
	56	KBTNT8LS202F2	2ft IP20 Batten fitting, comes with 2 x KHV10T8/FRO-W40	1
	56	KBTNT8LS204F1	4ft IP20 Batten fitting, comes with 1 x KHV20T8/FRO-W40	1
	56	KBTNT8LS204F2	4ft IP20 Batten fitting, comes with 2 x KHV20T8/FRO-W40	1
	56	KBTNT8LS205F1	5ft IP20 Batten fitting, comes with 1 x KHV25T8/FRO-W40	1
	56	KBTNT8LS205F2	5ft IP20 Batten fitting, comes with 2 x KHV25T8/FRO-W40	1
High Bay				
Circular High Bay	57	KMHD50FDC HB	50W LED Circular High Bay, 40000hrs, 4000K	1
	57	KMHD100FDC HB	100W LED Circular High Bay, 40000hrs, 4000K	1
Rectangular High Bay	58	KMSD150LHBE	150W LED High Bay, 40000hrs, 6500K	1
	58	KMSD200LHBE	200W LED High Bay, 40000hrs, 6500K	1
Rectangular Low Bay	59	KMSD100LLBF	100W LED Low Bay, 40000hrs, 6500K	1
	59	KMSD150LLBE	150W LED Low Bay, 40000hrs, 6500K	1
Tilt Twin Panel Low Bay	60	KPNLLS120T2S	120W LED Tilt Twin Panel Low Bay, 40000hrs, 4000K	1
Display				
Circular Wall Washer	61	KWWDL15	15W LED Downlight, 40000hrs, 16/36° Beam Angle, 3000K/5000K	1/18
	61	KWWDL24	24W LED Downlight, 40000hrs, 15/38° Beam Angle, 3000K/5000K	1/8
	61	KWWDL34	34W LED Downlight, 40000hrs, 15/40° Beam Angle, 3000K/5000K	1/8
Rectangular Wall Washer	62	KWWDL25Q	25W LED adjustable rectangular downlight, 40000hrs, 110° Beam Angle, 3000K/4000K/6000K	1
	62	KWWDL35Q	35W LED adjustable rectangular downlight, 40000hrs, 110° Beam Angle, 3000K/4000K/6000K	1
Tracklight	63	KTDL24GL	24W LED Tracklight, 40000hrs, 15/38° Beam Angle, 3000K/5000K	1/12
	63	KTDL34GL	34W LED Tracklight, 40000hrs, 15/40° Beam Angle, 3000K/5000K	1/8
	63	KTDL50GL	50W LED Tracklight, 40000hrs, 20/40° Beam Angle, 3000K/5000K	1/6
Spotlight Modular System	64	KRDL605M15	15W LED Spotlight Module, 40000hrs, 16/36° Beam Angle, 5000K	1/36
	64	KRDL615HW	Circular, Fixed, Recessed, Anti-glare, Matt White housing for KRDL605M15, 90mm cut-out	1/72
	64	KRDL615-BHS	Circular, Fixed, Recessed, Anti-glare, Silvered housing for KRDL605M15, 90mm cut-out	1/72
	64	KRDL635HW	Circular, Tilted, Angled, Recessed, Anti-glare, Matt White housing for KRDL605M15, 100mm cut-out	1/72
	64	KRDL642HW	Circular, Tilted, Matt White housing for KRDL605M15, 90mm cut-out	1/72
	65	KRDL606M24	24W LED Spotlight Module, 40000hrs, 15/38° Beam Angle, 5000K	1/36
	65	KRDL606HW	Circular, Tilted, Matt White housing for KRDL606M24, 100mm cut-out	1/72
	65	KRDL616HW	Circular, Fixed, Recessed, Anti-glare, Matt White housing for KRDL606M24, 115mm cut-out	1/72
	65	KRDL626HW	Circular, Fixed, Recessed, Anti-glare, Matt White housing for KRDL606M24, 125mm cut-out	1/72

MODEL	PAGE	STOCK CODE	DESCRIPTION (SHORT)	BOX QUANTITY (inner / outer)
	65	KRDL636HW	Circular, Tilted, Angled, Recessed, Anti-glare, Matt White housing for KRDL606M24, 125mm cut-out	1/72
	65	KRDL616-BHS	Circular, Fixed, Recessed, Anti-glare, Silvered housing for KRDL606M24, 115mm cut-out	1/72
	65	KRDL626-BHS	Circular, Fixed, Recessed, Anti-glare, Silvered housing for KRDL606M24, 125mm cut-out	1/72
	65	KRDL646-2HW	Rectangular, Tilted, Matt White twin housing for KRDL606M24, 255x125mm cut-out	1/72
	65	KRDL607M34	34W LED Spotlight Module, 40000hrs, 15/40° Beam Angle, 5000K	1/36
	65	KRDL607-1HW	Circular, Tilted, Matt White housing for KRDL607M34, 150mm cut-out	1/72
	65	KRDL607-2HW	Circular, Tilted, Anti-glare, Matt White housing for KRDL607M34, 150mm cut-out	1/72
	65	KRDL617HW	Circular, Recessed, Fixed, Anti-glare, Matt White housing for KRDL607M34, 150mm cut-out	1/72
	65	KRDL627HW	Circular, Recessed, Fixed, Anti-glare, Matt White housing for KRDL607M34, 170mm cut-out	1/72
	65	KRDL637HW	Circular, Recessed, Tilted, Angled, Anti-glare, Matt White housing for KRDL607M34, 170mm cut-out	1/72
	65	KRDL617-BHS	Circular, Recessed, Fixed, Anti-glare, Silvered housing for KRDL607M34, 150mm cut-out	1/72
	65	KRDL627-BHS	Circular, Recessed, Fixed, Anti-glare, Silvered housing for KRDL607M34, 170mm cut-out	1/72
	65	KRDL647-2HW	Rectangular, Tilted, Matt White twin housing for KRDL607M34, 315x160mm cut-out	1/72
	66	KRDL608M50	50W LED Spotlight Module, 40000hrs, 20/40° Beam Angle, 5000K	1/16
	66	KRDL608-1HW	Circular, Tilted, Matt White housing for KRDL608M50, 170mm cut-out	1/32
	66	KRDL608-2HW	Circular, Tilted, Anti-glare, Matt White housing for KRDL608M50, 170mm cut-out	1/32
	66	KRDL618HW	Circular, Recessed, Fixed, Anti-glare, Matt White housing for KRDL608M50, 170mm cut-out	1/32
	66	KRDL628HW	Circular, Recessed, Fixed, Anti-glare, Matt White housing for KRDL608M50, 210mm cut-out	1/32
	66	KRDL638HW	Circular, Recessed, Tilted, Angled, Anti-glare, Matt White housing for KRDL608M50, 210mm cut-out	1/32
	66	KRDL618-BHS	Circular, Recessed, Fixed, Anti-glare, Silvered housing for KRDL608M50, 170mm cut-out	1/32
	66	KRDL628-BHS	Circular, Recessed, Fixed, Anti-glare, Silvered housing for KRDL608M50, 210mm cut-out	1/32
Work Light				
Cordless Portable Work Light	67	KPWLLS10Q165	10W rechargeable portable work light, 40000hrs, 6000K	1/6
	67	KPWLLS30Q165	30W rechargeable portable work light, 40000hrs, 5000K	1/6
	67	KPWL-STAND	Iron Stand for KPWLLS10Q165 and KPWLLS30Q165	1
Module				
Linear Module (DC)	71	CYBC450L56/840	13.5W LED Board, 50000hrs, 4000K	200
	71	CYBC450L56/865	13.5W LED Board, 50000hrs, 6500K	200
	71	CYBC750L56/840	22.5W LED Board, 50000hrs, 4000K	200
	71	CYBC750L56/865	22.5W LED Board, 50000hrs, 6500K	200
	71	CYBC1350L360X130/840	40W LED Board, 50000hrs, 4000K	200
	71	CYBC330H560X40/865	36W LED Board, 50000hrs, 6500K	200
	71	CYBC450H745X40/865	54W LED Board, 50000hrs, 6500K	200
Linear Module (Mains)	72	CDBC65H280X50/865	15W LED Board, 50000hrs, 6500K	100
	72	CDBC135H560X50/865	30W LED Board, 50000hrs, 6500K	100
Driver				
Dimmable Drivers	31-37	KPNL-TRO25	Tridonic TALEXXdriver LCA 25W 350mA-1050mA, one-4all SR PRE (Suitable for KCDLLS16FR, KCDLLS24FR, KPNLLS18CF)	1
	31-37	KPNL-TRO30	Tridonic TALEXXdriver LCA 35W, 350mA-900mA ECO SR (Suitable for KLED30PNL, KLED30PNL0505, KPNLLS30LT-1203, KTWB30PNL)	1
	31-37	KPNL-TRO65	Tridonic TALEXXdriver LCA 65W, 900mA-1750mA ECO Ip (Suitable for KLED40PNL, KLED36PNL, KLED45PNL, KLED80PNL, KLED36PNL0303, KTWB40PNL, KMRC45L1A, KMRC45L2A, KPYD36PNL)	1

MODEL	PAGE	STOCK CODE	DESCRIPTION (SHORT)	BOX QUANTITY (inner / outer)
	31-37	CYC040TVC090	40W Dimmable Constant Current LED Driver, 900mA, 25-44Vdc, Two Stage, Terminals, 0-10V dimming (Suitable for KTWB30PNL)	1
	31-37	CYC060TVC135	60W Dimmable Constant Current LED Driver, 1350mA, 25-43Vdc, Two Stage, Terminals, 0-10V dimming (Suitable for KLED40PNL, KLED36PNL, KLED45PNL, KLED80PNL, KLED36PNL0303, KTWB40PNL, KMRC45L1A, KMRC45L2A, KYPD36PNL)	1
Constant Current Driver (for Class II luminaires)	73	CYC040TNC090	40W Constant Current LED Driver, 900mA, 25-44Vdc, Two Stage, Terminals	1
	73	CYV040TVC090	40W Constant Current LED Driver, 900mA, 25-44Vdc, Two Stage, Terminals, 1-10V Dimmable	1
	73	CYC060TNC135	60W Constant Current LED Driver, 1350mA, 25-43Vdc, Two Stage, Terminals	1
	73	CYC060TVC135	60W Constant Current LED Driver, 1350mA, 25-43Vdc, Two Stage, Terminals, 1-10V Dimmable	1
	73	CYC060TNC175	60W Constant Current LED Driver, 1750mA, 20-34Vdc, Two Stage, Terminals	1
	74	CYC024SNL055N	24W Constant Current LED Driver, 550mA, 33-45Vdc, Single Stage, Wired with connector	1
	74	CYC026SNL058N	26W Constant Current LED Driver, 580mA, 26-46Vdc, Single Stage, Wired with connector (Suitable for KCDLLS24FR, KRDL606M24)	1
	74	CYC036SNL080N	36W Constant Current LED Driver, 800mA, 30-46Vdc, Single Stage, Wired with connector (Suitable for KWWDL34, KRDL607M34)	1
	74	CYC036SNL091	36W Constant Current LED Driver, 910mA, 24-40Vdc, Single Stage, Wired with connector	1
	74	CYC062SNL135	62W Constant Current LED Driver, 1350mA, 26-46Vdc, Single Stage, Wired with connector	1
	74	CYC055SNL120	55W Constant Current LED Driver, 1200mA, 30-46Vdc, Single Stage, Wired with connector (Suitable for KRDL608M50)	1
	75	CYC008STL018N	8W Dimmable Constant Current LED Driver, 180mA, 30-42Vdc, Single Stage, Wired with connector (Suitable for KSDLLC08FF/DIM, KSDLLC08TF/DIM)	1
	75	CYC008SNL018N	8W Constant Current LED Driver, 180mA, 30-42Vdc, Single Stage, Wired with connector (Suitable for KSDLLC08FF, KSDLLC08TF)	1
	75	CYC010SNL023N	10W Constant Current LED Driver, 230mA, 28-44Vdc, Single Stage, Wired with connector	1
	75	CYC012SNL031N	12W Constant Current LED Driver, 310mA, 24-40Vdc, Single Stage, Wired with connector	1
75	CYC015SNL035N	15W Constant Current LED Driver, 350mA, 30-42Vdc, Single Stage, Wired with connector (Suitable for KRDL605M15)	1	
75	CYC016SNL037N	16W Constant Current LED Driver, 370mA, 28-44Vdc, Single Stage, Wired with connector (Suitable for KCDLLS16FR)	1	
75	CYC020SNL052N	20W Constant Current LED Driver, 520mA, 22-38Vdc, Single Stage, Wired with connector	1	
Constant Current Driver (for Class I luminaires)	76	CYC055SNC042	55W Constant Current LED Driver, 420mA, 80-132Vdc, Single Stage, Terminals	1
	76	CYC076SNC058	76W Constant Current LED Driver, 580mA, 80-132Vdc, Single Stage, Terminals	1
	76	CYC118SNC090	118W Constant Current LED Driver, 900mA, 80-132Vdc, Single Stage, Terminals	1
Constant Current Multifunction Dimmable LED Driver	77	CYC050TVC35-105	50W Constant Current LED Driver, 350-1050mA, 16-60Vdc, Two Stage, Terminals	1
Emergency Module				
Internal Plug-in Emergency Module	78	KTC27EME-DD	LED DD (9W/12W/18W Models) Emergency Module	1/25
	78	CEC019L8L050S	LED DD Self test Emergency Module	1/25
External Plug-in Emergency Module	79	CEC019L10L050N	Downlight Emergency Module (Suitable for KCDLLS08FR, KCDLLS10FR, KCDLLS16FR, KCDLLS24FR)	1/25
	79	CEC038L1L100N	Panel Emergency Module (Suitable for KLED30PNL, KLED40PNL, KLED30PNL0505, KLED36PNL, KLED45PNL, KLED80PNL, KPNLLS30LT-1203, KLED36PNL0303, KTWB30PNL, KTWB40PNL, KMRC45L1A, KMRC45L2A, KPYD36PNL, KPNLLS10CF, KPNLLS12CF, KPNLLS18CF)	1/25
	79	CEC019L10L050S	LED Panel Self test Emergency Module	1/25
	79	CEC038L1L100S	LED Panel Self test Emergency Module	1/25
Spiral				
CFL with Integrated Ballast	82	KCF05SP3	5W Extra-mini Spiral, B15/B22/E14/E27, 10,000hrs, 2700K	20/100
	82	KCF07SP3	7W Extra-mini Spiral, B15/B22/E14/E27, 10,000hrs, 2700K/4000K/6500K	20/100
	82	KCF09SP3	9W Extra-mini Spiral, B15/B22/E14/E27, 10,000hrs, 2700K/4000K/6500K	20/100
	82	KCF11SP3	11W Extra-mini Spiral, B15/B22/E14/E27, 10,000hrs, 2700K/4000K/6500K	20/100
	83	ECO09SP2	9W Quick Start Spiral, B22/E27, 8000hrs, 2700K	10/50
	83	ECO11SP2	11W Quick Start Spiral, B22/E27, 8000h, 2700K/4000K/6500K	10/50
	83	ECO15SP2	15W Quick Start Spiral, B22/E27, 8000h, 2700K/4000K/6500K	10/50
	83	ECO18SP2	18W Quick Start Spiral, B22/E27, 8000h, 2700K/4000K/6500K	10/50

MODEL	PAGE	STOCK CODE	DESCRIPTION (SHORT)	BOX QUANTITY (inner / outer)
	83	ECO20SP2	20W Quick Start Spiral, B22/E27, 8000h, 2700K/4000K/6500K	10/50
	83	ECO24SP1	24W Quick Start Spiral, B22/E27, 8000h, 2700K/4000K/6500K	10/50
	83	SIT11SP2	11W Spiral Sidelight Lamp, B22/E27, 8000h, 2700K	10/50
	83	SIT15SP2	15W Spiral Sidelight Lamp, B22/E27, 8000h, 2700K	10/50
	83	SIT20SP2	20W Spiral Sidelight Lamp, B22/E27, 8000h, 2700K	10/50
	83	ECO11ST2	11W Ecolight, B22/E27, 8000h, 2700K	10/50
	83	ECO20ST3	20W Ecolight, B22/E27, 8000h, 2700K	10/50
EXUN				
DD, T5C	84	KFT16STD	16W CFL EXUN DD, 2pin (GR8)/4P (GR10q), 12000hrs, 2700K/3500K/4000K/6500K	20
	84	KFT21STD	21W CFL EXUN DD, 4pin (GR10q), 12000hrs, 3500K	10/40
	84	KFT28STD	28W CFL EXUN DD, 2pin (GR8)/4P (GR10q), 12000hrs, 2700K/3500K/4000K/6500K	20
	84	KFT38STD	38W CFL EXUN DD, 4pin (GR10q), 12000hrs, 2700K/3500K/4000K	20/100
	84	KFT55STD	55W CFL EXUN DD, 4pin (GR10q), 12000hrs, 2700K/3500K/4000K	20/100
	84	KFT22STC	22W CFL EXUN T5C, 4pin (2GX13), 15000hrs, 4000K	20
	84	KFT40STC	40W CFL EXUN T5C, 4pin (2GX13), 15000hrs, 4000K	15
	84	KFT55STC	55W CFL EXUN T5C, 4pin (2GX13), 15000hrs, 4000K	15
S, D, T, L/E	85	KFT07ST1	7W CFL EXUN S/D, 2pin (G23), 10000hrs, 4000K	10/50
	85	KFT09ST1	9W CFL EXUN S/D, 2pin (G23), 10000hrs, 4000K	10/50
	85	KFT11ST1	11W CFL EXUN S/D, 2pin (G23), 10000hrs, 4000K	10/50
	85	KFT10ST2	10W CFL EXUN S/D, 2pin (G24d-1)/4pin (G24q-1), 10000hrs, 4000K	10/50
	85	KFT13ST2	13W CFL EXUN S/D, 2pin (G24d-1)/4pin (G24q-1), 10000hrs, 4000K	10/50
	85	KFT18ST2	18W CFL EXUN S/D, 2pin (G24d-2)/4pin (G24q-2), 10000hrs, 4000K	10/50
	85	KFT26ST2	26W CFL EXUN S/D, 2pin (G24d-3)/4pin (G24q-3), 10000hrs, 4000K	10/50
	86	KFT13ST3	13W CFL EXUN T, 4pin (GX24q-1), 10000hrs, 4000K	10/50
	86	KFT18ST3	18W CFL EXUN T, 4pin (GX24q-2), 10000hrs, 4000K	10/50
	86	KFT26ST3	26W CFL EXUN T, 4pin (GX24q-3), 10000hrs, 4000K	10/50
	86	KFT42ST3	42W CFL EXUN T, 4pin (GX24q-4), 10000hrs, 4000K	10/50
	86	KFT18STL	18W CFL EXUN L/E, 4pin (2G11), 10000hrs, 4000K	10/50
	86	KFT24STL	24W CFL EXUN L/E, 4pin (2G11), 10000hrs, 4000K	10/50
	86	KFT36STL	36W CFL EXUN L/E, 4pin (2G11), 10000hrs, 4000K	10/50
	86	KFT40STL	40W CFL EXUN L/E, 4pin (2G11), 10000hrs, 4000K	10/50
	86	KFT55STL	55W CFL EXUN L/E, 4pin (2G11), 10000hrs, 4000K	10/50
T5, T8	87	KFT08T5	8W CFL EXUN T5, 288mm, 20000hrs, 4000K	100
	87	KFT14T5	14W CFL EXUN T5, 549mm, 20000hrs, 4000K	50
	87	KFT21T5	21W CFL EXUN T5, 849mm, 20000hrs, 4000K	50
	87	KFT28T5	28W CFL EXUN T5, 1149mm, 20000hrs, 4000K	50
	87	KFT35T5	35W CFL EXUN T5, 1449mm, 20000hrs, 4000K	50
	88	KFT24T5HO	24W CFL EXUN T5 (High Output), 549mm, 20000hrs, 4000K	50
	88	KFT39T5HO	39W CFL EXUN T5 (High Output), 849mm, 20000hrs, 4000K	100
	88	KFT49T5HO	49W CFL EXUN T5 (High Output), 1449mm, 20000hrs, 4000K	50
	88	KFT54T5HO	54W CFL EXUN T5 (High Output), 1449mm, 20000hrs, 4000K	50
	88	KFT18T8	18W CFL EXUN T8, 589mm, 15000hrs, 4000K	25
88	KFT30T8	30W CFL EXUN T8, 894mm, 15000hrs, 4000K	25	
88	KFT36T8	36W CFL EXUN T8, 1199mm, 15000hrs, 4000K	25	
88	KFT58T8	58W CFL EXUN T8, 1500mm, 15000hrs, 4000K	25	
Classic Shape				
Candle, GLS, Golf, Reflector	91	KHL18CND	18W HALO Candle Halogen Saver, B22/E14, 2000hrs, 3000K	20/100
	91	KHL28CND	28W HALO Candle Halogen Saver, B15/B22/E14/E27, 2000hrs, 3000K	20/100
	91	KHL42CND	42W HALO Candle Halogen Saver, B15/B22/E14/E27, 2000hrs, 3000K	20/100
	91	KHL28BTP	28W HALO Candle Bent-Tip Halogen Saver, B15/B22/E14/E27, 2000hrs, 3000K	20/100
	91	KHL42BTP	42W HALO Candle Bent-Tip Halogen Saver, B22/E14/E27, 2000hrs, 3000K	20/100
	92	KHL28GLS	28W HALO GLS Halogen Saver, B22/E27, 2000hrs, 3000K	20/100
	92	KHL42GLS	42W HALO GLS Halogen Saver, B22/E27, 2000hrs, 3000K	20/100
	92	KHL70GLS	70W HALO GLS Halogen Saver, B22/E27, 2000hrs, 3000K	20/100

MODEL	PAGE	STOCK CODE	DESCRIPTION (SHORT)	BOX QUANTITY (inner / outer)
	92	KHS18GLF	18W HALO Golf Halogen Saver, B22/E14/E27, 2000hrs, 3000K	20/100
	92	KHS28GLF	28W HALO Golf Halogen Saver, B15/B22/E14/E27, 2000hrs, 3000K	20/100
	92	KHS42GLF	42W HALO Golf Halogen Saver, B15/B22/E14/E27, 2000hrs, 3000K	20/100
	92	KHL28R50	28W HALO Reflector Halogen Saver, R50, E14, 2000hrs, 3000K	20/100
	92	KHL42R63	42W HALO Reflector Halogen Saver, R63, E27, 2000hrs, 3000K	20/100
	92	KHL42R80	42W HALO Reflector Halogen Saver, R80, E27, 2000hrs, 3000K	20/100
	92	KHL72R80	72W HALO Reflector Halogen Saver, R80, E27, 2000hrs, 3000K	20/100
Reflector				
GU10, G5.3, MR11	93	KHL25MR16/GU10	25W HALO GU10 Halogen Lamp, 2000hrs, 3000K Alternative to KHL20MR16/GU10	100
	93	KHS28MR16/GU10	28W HALO GU10 Halogen Saver Lamp, 2000hrs, 3000K Alternative to KHL35MR16/GU10	100
	93	KHS42MR16/GU10	42W HALO GU10 Halogen Saver Lamp, 2000hrs, 3000K Alternative to KHL50MR16/GU10	100
	93	KHL15MR16/G5.3	15W HALO MR16, G5.3 Dichroic/Aluminium Halogen Lamp, 2000hrs, 3000K Alternative to KHL20MR16/G5.3-DIC	100
	93	KHL35MR16/G5.3	35W HALO MR16, G5.3 Dichroic/Aluminum Halogen Lamp, 2000hrs, 3000K	20/200
	93	KHL50MR16/G5.3	50W HALO MR16, G5.3 Dichroic/Aluminum Halogen Lamp, 2000hrs, 3000K	20/200
	93	KHS25MR16/G5.3	25W HALO MR16, G5.3 Dichroic/Aluminium Halogen Lamp, 2000hrs, 3000K Alternative to KHS20MR16/G5.3-DIC-830	100
	93	KHS40MR16/G5.3	40W HALO MR16, G5.3 Dichroic/Aluminum Halogen Lamp, 2000hrs, 3000K Alternative to KHS35MR16/G5.3-ALU-830	100
	93	KHL20MR11	20W HALO MR11, GU4 Dichroic Halogen Lamp, 2000hrs, 3000K	20/200
	93	KHL35MR11	35W HALO MR11, GU4 Dichroic Halogen Lamp, 2000hrs, 3000K	20/200
Capsule				
G9, G4, GY6.35	94	KHS18CPL/G9-CLE	18W HALO G9 Halogen Saver Capsule Lamp, 2000hrs, 3000K	1000
	94	KHS28CPL/G9-CLE	28W HALO G9 Halogen Saver Capsule Lamp, 2000hrs, 3000K	100/100
	94	KHS42CPL/G9-CLE	42W HALO G9 Halogen Saver Capsule Lamp, 2000hrs, 3000K	100/100
	94	KHL10CPL/G4-CLE	10W HALO G4 Capsule Lamp, 2000hrs, 3000K	100/100
	94	KHL20CPL/G4-CLE	20W HALO G4 Capsule Lamp, 2000hrs, 3000K	100/100
	94	KHL35CPL-GY6.35-CLE	35W HALO GY6.35 Capsule Lamp, 2000hrs, 3000K	100/100
	94	KHL50CPL-GY6.35-CLE	50W HALO GY6.35 Capsule Lamp, 2000hrs, 3000K	100/100

* New product for 2016, please contact the sales office for more information

Terms & Conditions:

- 1) All prices in GBP excluding VAT and delivery
- 2) Prices & specifications subject to change without notice
- 3) Prices valid from 1st March 2016
- 4) E&OE

Important Information

The information, technical specification and photography contained in this catalogue is representative of general models, correct at the time of going to press. All dimensions and weight given are advisory and should be checked and confirmed prior to any crucial installation procedures such as ceiling cut-outs taking place.

Whilst suggestions regarding luminaire and lamp applications are given, it is the responsibility of the installer to verify suitability.

Kosnic Lighting Ltd reserves the right to make any modification necessary to parts or details without prior notice. The information contained in this publication does not form part of any contract with Kosnic Lighting Ltd and any item supplied is done in full accordance of our Terms and Conditions of Sales (copy available on request)



Kosnic Lighting Ltd.
Unit D2 Kennetside, Bone Lane
Newbury, Berkshire, UK
RG14 5PX

Tel: 0845 8386851
Fax: 0845 8386852
sales@kosnic.com
www.kosnic.com

